

650 Students Tour Library



An estimated 650 school children and teachers toured the Wayne City library last week in observance of Children's Book Week. Shown above are Wayne Prep second graders who took the tour Friday morning.

As with other groups, they were shown a film by Librarian Mrs. F. A. Milder, told a story, and invited to inspect the displays of new children's books.

Set Rehearsals For Messiah

Rehearsals for the annual Wayne Kiwanis club presentation of Handel's "The Messiah" will start Sunday, Dec. 4, it was announced today by Director Russel Anderson.

Funeral Services Held Wednesday For Mrs. Gossard

Funeral services were held Wednesday afternoon in the Methodist church for Mrs. Amzi Philip Gossard, 61, who died Sunday. Rev. O. K. Brandstetter and John Carlson sang "Higher Ground" and "O, That Would Be Glory."

Planning Meet Held for Transfer of Haskell Farm

Jaycees Prepare Caroling Party for Wayne Youths

Wayne Jaycees Tuesday night laid plans for their annual Christmas caroling party. Members as co-leaders of the event were John Hanson and John Carlson.

John Barr Named One-Year Director of Northeast Nebraska Dry Cleaners Association

John Barr was named a one-year director of Northeast Nebraska Dry Cleaners association Sunday at the group's meeting.

Deadline Near on \$54 Personal Tax

County Treasurer Leona Bahde reminded county residents this week that the first half of 1954 personal property taxes will become delinquent Dec. 1.

Former College Head, Wife Celebrate Golden Wedding Anniversary

Dr. and Mrs. J. T. Anderson, Long Beach, Calif., marked their golden wedding anniversary Nov. 6 at their California home.

Children's Society to Start County Campaign For Funds Next Week

George O. Macklin, Wayne, financial representative for Nebraska Children's Home society will lead a campaign about Dec. 1 to conduct the annual solicitation.

Markets

Table with market prices for various commodities like corn, oats, beans, etc. in Wayne Wednesday a.m.

Engineers to Start Work on Highway 35 Relocation Soon

Total Cost of Project \$593,701. State Highway department engineers are expected to start staking the relocation of Highway 35 between Wayne and Wakefield early next week.

Monday Services At Concord for A. E. Fredrickson

Funeral services for Andrew Edward Fredrickson, 86, were held in the Concordia Lutheran church, Concord, Monday at 2 p.m.

Chinese Block Prints Displayed At Wayne State

A display of contemporary Chinese color block prints by Seong May Chung Oriental artist is on exhibit at the WSTC student union.

Services Held Wednesday for Rodney Hank, Accident Victim

Funeral services for Rodney J. Hank, 16, were held Wednesday morning at Immanuel Lutheran church northwest of Wayne.

Vanderbilt Rites Held Monday at Randolph Chapel

Funeral rites were held Thursday for George H. Vanderbilt, 80, who died from a heart attack in his home last Monday afternoon.

10 Killed in Sunday Night Auto Crash

Funeral services for Rodney J. Hank, 16, were held Wednesday morning at Immanuel Lutheran church northwest of Wayne.

Local Youth Among Top At State Music Clinic

Hastings' Irving Carlson, son of Mr. and Mrs. Albert G. Carlson, Wayne, was among the top musicians selected at the state music clinic here last week.

400 at County Feeders Banquet Thursday Night

Approximately 400 persons attended the annual Wayne County Feeders association banquet Thursday night at the city auditorium.

County Bond Sales Now Over \$561,000

Sales of U.S. savings bonds in Wayne county totaled \$53,406 during October.

Russian Prices Eight Times Higher Than Ours

Large enough to provide adjoining shelter for livestock. Some of the larger collective farm villages have churches and I also saw several churches in the cities.

Eggs Sell at Quarter Each, Dresses \$125

Last of a series of seven articles on Russian agriculture by Dr. W. V. Lambert, chief of the U.S. delegation which traveled 10,000 miles behind the Iron Curtain.

License Examiners At Wayne Friday

Examiners will be at the Wayne courthouse Friday afternoon to give examinations for driver's licenses.

The HERALD Phone Number 130 IS

Stores Slate Christmas Hours

Calendar for December 1955 showing store hours for various days.

SOUTHEAST: Wakefield

Mrs. Ellis Johnson
Phone Atlas 7-2346

Parents Visit School
Parents of District 1 were invited to visit classes Wednesday evening. Two film strips were shown in connection with class work and pupils presented two plays. Mrs. Verner Fischer and pupils served doughnuts and coffee.

Mrs. Eldon Baretman, Mrs. Dick Mecht and Mrs. C. L. Band met with Mrs. Paul Everingham Wednesday afternoon for a Setve-All club committee meeting.

Mr. and Mrs. Donald Fleetwood and children were entertained at

Sunday dinner and lunch to the Reuben family. Mr. and Mrs. Alden Johnson and children were supper guests in the Harold Olson home Thursday evening to celebrate the birthdays of Janice and Lowell, who were eight that day.

Friday evening Mr. and Mrs. Mark Stringer and family, Wayne, brought birthday cake and visited in the Harold Olson home for Janice's birthday and Marilyn Stringer's tenth of Saturday.

Sunday dinner and supper guests in the Harold Olson home were Mr. and Mrs. Charles Bradenburgh and family, Uchling and Mr. and Mrs. Al Hojkes and children.

Mr. and Mrs. Darwin Nimrod and children were Thursday supper guests in the Ernest Winegardner home.

A group of ladies brought a cooperative birthday lunch and

visited Mrs. Olive Lamb Tuesday afternoon.

The Ray Hallgren and Darwin Nimrod families were Friday evening visitors at the Norman Swanson home to help Linda celebrate her second birthday.

The Cecil Rhodes family and Walter Chinn were Sunday dinner guests in the Charles Keyser home.

Mr. and Mrs. Bill Robertson, Wayne, were Sunday evening visitors in the Verdel Lund home.

Mrs. Olive Lamb and Mrs. Lettie Harman were entertained at Sunday dinner and lunch in the Carl Sundel home.

Mr. and Mrs. Emil Swanson and Mr. and Mrs. George Magnuson, Wayne, were Tuesday evening visitors in the Nels Bjorklund home helping Eunice celebrate her birthday.

Reuben Goldberg, Janison and Maturon were Sunday afternoon visitors and supper guests to further observe the event.

Mrs. Darwin Nimrod, Mrs. Reuben Goldberg and Mrs. Charles Pierson attended the district Sunday school meeting at Wausa Sunday afternoon.

Ellis Johnson was a Sunday dinner guest in the Harry Oak home and luncheon guest in the L. J. Bressler home.

Mr. and Mrs. Charles Kinney were Sunday afternoon and supper guests in the Walter Otte home.

Mrs. Walter Chinn and Mrs. Ellis Johnson visited in the homes of Mrs. Weitha Winthers and Mrs. Selma Munson, Fort Dodge, Ia., over the weekend.

The Bob Johnson family visited in the Jim Wideman home near Allen Friday evening.

Mr. and Mrs. George Spoonstra and Dorothy Jean, Omaha, visited Mrs. Ada McCorkindale Saturday.

Mr. and Mrs. Bill Harrison and son, Wayne, and Mr. and Mrs. Paul Everingham, Karen and Kenney were entertained at supper Thursday evening in the Ted Harrison home.

Mr. and Mrs. Elyk S. Johnson were Friday evening visitors in the Ellis Johnson home.

The Cecil Rhodes family, Mr. and Mrs. L. J. Bressler, Tommy and Bette, and Mr. and Mrs. Ellis Johnson were entertained in the Walter Chinn home Monday evening to help Mr. Chinn celebrate his birthday.

Lis Kinney accompanied members of the basic art class to Omaha to visit the Joslyn museum Tuesday.

Mr. and Mrs. Ted Harrison visited in the Russell Harrison home Sunday afternoon.

Mr. and Mrs. Phillip Ring and sons visited in the Marion Ring home, Wayne, Sunday afternoon.

Friday evening Mr. and Mrs. Roy Pierson and Mr. and Mrs. Dean Pierson and Chuckie were entertained at dinner in the Charles Pierson home for the host's birthday.

Mr. and Mrs. Clarence Schines, Myrna and Merle and Mr. and Mrs. James Hallstrom and son were entertained at dinner Sunday evening in the home of Mr. and Mrs. Walter Small, Decatur.

Mrs. Don Johnson, Douglas and Dallas were dinner guests in the Gerald Becker home last Monday.

Visitors in the Fred Roebor home Saturday were Mr. and Mrs. Gerald Becker and David, Mr. and Mrs. Don Johnson and sons and Mr. and Mrs. J. Milford Roebor, Mike and Mark.

Sunday evening Mrs. Don Johnson attended a shower in honor of Mrs. Alvin Anderson in the Elhardt Pospisil home.

Mr. and Mrs. Lloyd Roebor and Mr. and Mrs. Gerald Becker were dinner guests in the Fred Roebor home Monday.

T. S. Hook was in Lincoln Saturday to attend a meeting of the State Hospital Advisory board.

Mrs. Mae Ellis, York, is visiting in the home of Mr. and Mrs. Fred Ellis and other friends.

Recent Bride



Shown above is Mrs. Jerry Korff, the former Marilou Siegert, daughter of Mr. and Mrs. George Siebert. The couple were married Nov. 6 at Butte.

Patty Morris and Robert Curry Wed Sunday Afternoon

Patty Lou Morris, daughter of Mr. and Mrs. E. M. Morris, Wayne, and Robert Lawrence Curry, son of Mr. and Mrs. Leland Curry, South Sioux City, were married Sunday afternoon in Wayne Methodist church. Rev. A. B. Gray officiated at the double ring ceremony. The church was decorated with bouquets of white mums and pink snapdragons.

The bride wore a white, princess style afternoon dress with pink accessories. She carried a red rose corsage on a white Bible.

Maid of honor was Virginia Arthur, Storm Lake, Ia. She wore an aqua dress with black accessories and wore a pink carnation corsage.

Donald Curry, brother of the bridegroom, was best man. Ushers were Bob Henegar and Ken Anderson. The men wore dark suits.

Mother of the bride wore a peach brown dress. The bridegroom's mother wore a navy blue dress.

A reception was held in the Woman's club rooms. The pink and white, five-tier wedding cake was baked by Mrs. Roy Spahr and Mrs. Elmer Echtenkamp. Helping in the kitchen were Mrs. Roy Day, Mrs. Roy Spahr, Mrs. Claude Harder and Mrs. Elmer Echtenkamp.

Mrs. Lowell Rabe, Edith Curry and Marilyn Henegar were in charge of the gifts. Kay Halle presided at the guest book. Marilyn Day and Mrs. Morris Sangahi

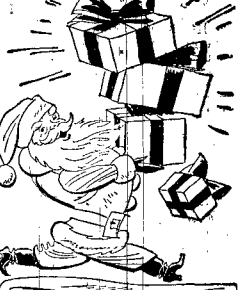

Santa Shops at WAYNE BOOK for Sheaffer's

NEW SNORKEL PEN

Here's the most popular gift on Santa's list — the world's only clean-filling pen. And in our selection you'll have a model and color choice at all prices. Drop in today!

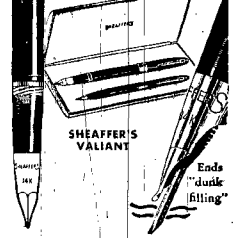

Wayne Book Store
"We Sell Almost Everything"
219 Main Phone 110

visited Mrs. Stanley Morris put the wedding cake.

The bride graduated from Wayne High and attended WSTC. The bridegroom graduated from South Sioux City high school, attended WSTC, served four years in the Navy and is now employed as an accountant in Sioux City. After a trip to Minnesota the couple will live in Sioux City.

Altona

By Staff Correspondent

Mr. and Mrs. Claude Harder and family were Sunday evening visitors in the Allen Shufelt home.

Mrs. Henrietta Siegert is now staying in the home of her daughter, Mrs. George Thompson.

Mrs. Art Hageman was a Sun-

day visitor in the George Thompson home.

Mr. and Mrs. Donald Cauwe and daughter, Norfolk, were Friday evening supper guests in the E. P. Cauwe home.

Sunday callers in the J. H. Spahr home were Mr. and Mrs. E. P. Cauwe.

Mr. and Mrs. Albert Sundell, Wakefield, were Sunday evening callers in the E. P. Cauwe home.

Mrs. Ida Longe and family visited in the Arthur Longe home, Wakefield, Sunday afternoon.

Mr. and Mrs. Delmer Paulsen were Sunday evening guests in the home of Mrs. Ida Longe.

Mr. and Mrs. Melvin Wert visited in the home of Dr. and Mrs. Charles Ingham, Norfolk, Sunday afternoon. Mrs. Albert Ross and Ruth accompanied them.

Mr. and Mrs. Archie Wert and family were Sunday evening call-

"See by The Herald"

Mr. and Mrs. Lloyd Straight, T. S. Hook and Mrs. Grace Lamb were in Primghar, Ia. Sunday for the christening of James Robert, son of Mr. and Mrs. Dale Craun.

Mr. and Mrs. Verlyn Lamb, Sioux City, were also there.

Monday Rev. O. B. Proett and T. S. Hook went to Omaha to a

meeting in the Melvin Wert home. Friday evening callers were Mr. and Mrs. Melvin Bruns and Janie, Pender, and Mr. and Mrs. Ed Watkins and Barbara.

Those helping Susan Wert celebrate her birthday in the Melvin Wert home Saturday evening were Mr. and Mrs. Albert Gamble and boys and Mr. and Mrs. Don Milliken.

committee meeting on long range planning for the Presbyterian church of Nebraska. Those who attended the consistory memorial in Sioux City.

Carol club met Friday afternoon in the home of Mrs. Ross Baker. After games were played luncheon was served.

George Stringer and Marday Meier, Winside, were Sunday dinner guests in the Ray Perdue home. Mr. and Mrs. Mark Stimes were visitors in their home Sunday evening. Saturday Mrs. Matt Sawyer Dougherty called on them.

Mrs. Ida Leonard and family were Sunday visitors in the Al Dilts home, Wakefield.

Mr. and Mrs. Charles Hoffman, O'Neill, were Sunday callers in the Henry Redner home.

Mrs. A. G. Bang, Edna and Eric O'Neill, called on Mrs. Elta Albin Sunday in the Ray Perdue home.

Kids . . .
Bring the Folks in for Dinner and . . .
Get Free Tickets for Rides on the Miniature Train Friday - Saturday
Jerry's Cafe

LUCKY NUMBERS
FOR VALUABLE MERCHANDISE PRIZES!
See IF YOUR NUMBER IS POSTED IN OUR STORE!
Check to See if the RED NUMBER ON THE BACK of your SALE CATALOG is among them. Many valuable merchandise prizes given FREE to the holders of the LUCKY NUMBERS.
COAST-TO-COAST STORES
LOCALLY OWNED NATIONALLY ORGANIZED

Another Happy OLDSMOBILE Dealer

No matter how you look at it, Oldsmobile for 1956 is the most beautiful car on the road. Look at this Super 88 Deluxe 4-Door of Dr. John D. Rice, president of Wayne State Teachers College. There's future styling that promises the ultimate in new-car looks for years to come.

And no matter where or when you drive it, Oldsmobile has all the super power and satisfying comfort you want for today's modern driving. It's easy to get all the facts about Oldsmobile—just ask any owner . . . Ask Dr. Rice, for instance. This is his third Coryell Oldsmobile. It's common knowledge that Oldsmobile develops proud owners. Why don't you talk it over with us today?

CORYELL AUTO COMPANY
Your CHEVROLET — OLDSMOBILE Dealer
112 E. 2nd Phone 152

It's Swans' . . . For the Finest in Everything a Man Wears

Jackets
Fabrics and fashion meant for each other! In warm sportswear for work or play.
THE FABRIC—wool fleeces, tweeds, plaids and fancies.
THE FASHION—new stadium styles, zipper or button. The blouse with knit waistband, cuffs and stand-up knit collar.
Milium lined styles, no bulk, just pure comfort. Milium linings are warmer in cold weather and cooler under a hot sun.
9.95 to 35.00

Suits . . .
By Curlee, Brookfield, Mayfield and Griffon.
Flannels, gabardines, shetlands and worsteds.
Styled for fall in the new autumn shades.
From 37.50 to 65.00

Topcoats . . .
By Curlee, Mayfield 4-Star and Griffon.
Tweeds, coverts, gabardines and cashmeres.
Smart styling! Quality tailoring! Newest shades!
Priced from 35.00 to 60.00

Relax in Style!
Wear a sport coat with slacks to match or contrast.
Choose from a variety of new patterns in new styles.
Coats 22.50 to 35.00
Lissner Slacks 8.95 to 18.95

Why Not Resolve NOW TO . . . Shop Early!
for your man's Christmas

Beat the Crowds to the Best Buys
IT'S OUR BUSINESS
to know exactly what he wants, so decide now to select gifts for every man on your list at this store.
You'll like our friendly service to help you pick just the right gift for him.

Don't Fail to Register Your Boy in Our Birthday Club!
He'll be thrilled to receive a free gift certificate on his next birthday.
Boys from 5 years to 13 years are eligible.

SWANS' CLOTHING
FOR MEN AND BOYS

Friday, Nov. 25
 St. Joseph's Ladies
 Saturday, Nov. 26
 St. Paul's dinner and bazaar
 Monday, Nov. 28
 Redeemer Missionary Study
 Group—Martin Ringer
 No. Club
 St. Joseph's Couples Study
 U.D.—Mrs. Jessie Reynolds
 Coterie—Mrs. L. A. Welch
 Tuesday, Nov. 29
 Delta Dek—Mrs. Ed. Wolske
 Wednesday, Nov. 30
 Methodist Circle II—Mrs. K. M. Olds
 Methodist Circle I—Mrs. Ed. Seymour
 Thursday, Dec. 1
 King's Daughters—Mrs. Ann Swinney
 St. Paul's Altar Guild
 Redeemer Lutheran Aid
 Christmas party
 EOT—Mrs. Martin Rasmussen
 Altona Trinity Lutheran Aid

SOCIAL EVENTS

Antiques Displayed at
 Minerva Club Monday
 Eleven members attended Minerva club Monday in the home of Mrs. E. L. Harvey. Mrs. Yale Kessler was program chairman. She displayed some antique jewelry, silverware and books. Next meeting will be in the J. D. Rice home.
 BFW Hears Talk on
 Budget Importance
 BFW met Tuesday evening in the Hotel Morrison with 12 members present. LeRoy Cunnigham spoke on the importance of a budget. Eleanor Edwards and Mrs. Lelia Bush were on the program committee. Dec. 13 meeting will be a Christmas party.
 Two Guests Attend
 Bridgette Meeting
 Bridgette club met Monday in the home of Mrs. Charles McDermott. Guests were Mrs. Bob Harrison and Mrs. Ben Vikon. Mrs. Lyle Seymour and Mrs. H. D. Addison won prizes. Next meeting will be a Christmas party.
 New Homemakers Have
 Lesson On Salads
 New Homemakers met Thursday in the home of Mrs. Paul Dauberg with 13 members attending. Mrs. Harold Suter was a guest. Mrs. Don Johnson and Mrs. John Anderson gave the lesson on salads. The next meeting will be in the home of Mrs. Merlin Saut.

Sandra Haas Honored at
 Miscellaneous Shower
 Sandra Haas was honored at a miscellaneous shower Friday evening in the Woman's Club rooms. Forty guests were present for a evening of games and contests. Prizes were won by Rosalind Dunklau, Mrs. Walter Phipps, Mrs. Gerald Hasebroeck and Mrs. Harry Beckner. The gift table was decorated in the bridal colors of blue and white. The centerpiece was a bridal doll set of by two blue candles.
 Hostesses were Mrs. Ray Klind, Mrs. Marvin Peterson, Mrs. Darrell Harrison, Mrs. Jake Reibold, Mrs. Gordon Beckner, Mrs. Duane Lindsay, Mrs. Avina Brudigan and Fauna Dieck.
 Miss Hans will wed Robert Likes Dec. 27 in the Presbyterian church.

Redeemer Lutheran
 Ladies Aid
 Present their annual roast beef dinner, bazaar, country store and afternoon luncheon
 Saturday, Dec. 3
 in the City Auditorium
 Dinner starts at 11 o'clock
 Prices are:
 Adults \$1.00 Children 65c
 PUBLIC IS INVITED
 n2112

See the
 New Winter Hats
 Styled to Compliment Your Coat!
 Whites, Pastels and Blacks
 with Rhinestone Trimming
 5.00 and better

SWANS' APPAREL FOR WOMEN

Social and Club News

★ WEDDINGS ★ REUNIONS ★ CLUB MEETINGS ★ SOCIAL EVENTS

Fifteen Attend Jolly Sewing Circle
 Jolly Sewing circle met last Wednesday in the home of Mrs. Will Lutz. Games were played and Mrs. Wilfred Nelson won the door prize. Fifteen ladies were present. The next meeting will be in the home of Mrs. Nelson.

Mother's Study Club Views Shyness Film
 Mrs. Catherine Shell showed a film on shyness to Mother's Study club Thursday. An auction of articles made by members was held. Mrs. L. W. McJannet, Jr. and Mrs. Lee Swinney were hostesses at the McNab home to the 12 members and eight guests.

Lenore Ramsey Is Quiz Mistress at Woman's Club
 Woman's club met Friday in the club rooms. Patty and Sonja Anderson sang two songs. Scholarship winners Doris Foster and Donna Miller gave personal thanks you to the ladies at the meeting. Program Chairman Lenore Ramsey was in charge of a quiz program. Prizes went to Mrs. Ralph Eaton and Mrs. Dave Theophilus. Hostesses were Mrs. Hobart Aulker, Mrs. Art Aulker, Mrs. O. G. Nelson, Mrs. George Noakes, Mrs. Basil Osburn, Mrs. A. F. Morris, Mrs. Earl Merchant and Mrs. A. W. Ross.

Methodist Circle IV Meets In Jack Hurd Home
 Methodist Circle IV met last Wednesday in the home of Mrs. Jack Hurd with nine members attending. Mrs. Evan Hamr was a guest. Mrs. Ismael Higgins was devotional leader and Mrs. Orville Sherry was in charge of the program. Hostesses were Mrs. Jack Hurd and Mrs. Max Hendrickson.

EOT Has Card Party In Gilmore Sals Home
 EOT met Friday in the Gilmore Sals home for a social evening of cards. Mrs. Gene Sandahl was assistant hostess. Guests were Mr. and Mrs. Allan Perdue and family. Prizes were won by Mrs. George Sieger, Mrs. Harry Hotell, Mr. and Mrs. Ray Finn, Allan Perdue and Ray Hansen. The next meeting will be in the Martin Rasmussen home.

Housewarming Held for Ben Vikens Saturday
 A housewarming party was held Saturday evening for Mr. and Mrs. Ben Vikon. Guests were Mr. and Mrs. Roy Christensen, Mr. and Mrs. Bob Harrison, Mrs. Adon Jeffrey, Mr. and Mrs. Charles McDermott and Mr. and Mrs. Bob Johnson.

Missionary Speaks at Acme Dinner Meeting
 Husbands and friends of Acme members joined them at a dinner at Hotel Morrison Monday evening. Mrs. Gus Hinrich sang a solo. Esther Obweg, missionary on furlough from Tanganyika, Africa, showed colored pictures of Africa and talked on work, schools and customs of the African people.

St. Paul's Evening Circle Meets for Bible Study
 St. Paul's Evening Circle met Thursday for Bible study. Rev. W. G. Volker was in charge. Mrs. Minor Fischer gave devotions. Mrs. Volker was a guest. Mrs. Lloyd Bradford served.

Rural Home Meets In Dick Sandahl Home
 Rural Home met Thursday in the home of Mrs. Dick Sandahl. Mrs. Merlin Hasenkamp was a guest. The ladies brought clothing for the Nebraska Children's home. Coffee strips were also collected. Mrs. F. A. Suter was entertainment chairman. Mrs. Emil Lund won the contest prize. The next meeting will be a Christmas party in the Maple Rim home with exchange of gifts. A two course luncheon was served by the hostess.

Pleasant Valley Gives To Children's Home
 Pleasant Valley met last Wednesday in the Woman's Club rooms. Mrs. Raymond Larsen and Mrs. Ed Frevert were hostesses. It was decided to give \$10 to the Children's Home in Omaha for Christmas gifts. "Nurt" was played with prizes going to Mrs. Albert Damm and Mrs. Dale Thompson. Mrs. Merlin Preston received the door prize. The next meeting will be a Christmas party with gift exchanges in the home of Mrs. Albert Bichel.

St. Paul's Women Elect Officers
 St. Paul's Women met Thursday. Opening devotions were led by Mrs. Marvin Johnson. Election of officers was held. Mrs. Ardale Test was elected president; Mrs. Basil Osburn, vice president; Mrs. Marvin Johnson, secretary; Mrs. Elder Lubberstedt, treasurer; and Mrs. Norris Weible, statistical secretary. Rev. W. G. Volker gave a review of the Twenty-third Psalm. Sonja and Patty Anderson sang two selections. Serving chairman was Mrs. John Bush. The next meeting will be at 1 o'clock luncheon Dec. 8.

St. Peter's Couples Club Honor Ambrose Jordans
 St. Peter's Couples Study club completed the lesson on Eastern rites of the church at Monday night's meeting. They met at the Joe Pinkelman home. A gift was presented to Mr. and Mrs. Ambrose Jordan, who are moving to Fremont.

Immanuel Lutheran Aid Elects New Officers
 Immanuel Lutheran aid met Thursday in the church parlors. Rev. T. H. Buehner led devotions. Thirty members attended. Guests were Mrs. Gilbert Rauss and Mrs. Gilbert Krallman. Plans were made for a family Christmas party Dec. 11 in the church parlors. Committees for the occasion were appointed. New officers are Mrs. Harvey Echtenkamp, president; Mrs. Paul Lessman, vice president; Mrs. Herbert Echtenkamp, treasurer; and Mrs. Rudolph Roeder, secretary. Conrad Weierhauser is chairman of the home committee. Mrs. Laurence Ruwe, Mrs. Arnold Roeder and Mrs. Fred Ruser are on the sympathy committee. Auditing committee consists of Mrs. Alvin Roeder and Mrs. Marvin Nelson. Hostesses for the day were Mrs. Albert Echtenkamp and Mrs. Rudolph Roeder.

Two Guests Attend Methodist Circle III
 Methodist Circle III met last Wednesday in the home of Mrs. Fred Gildersleeve. Mrs. Clarence Bronzynski was assistant hostess. Fifteen members were present. Guests were Mrs. J. F. Sargent, Gettysburg, S. D. and Mrs. Fred Vorce. Mrs. Milton Ochsenr joined the circle. Devotions were led by Mrs. Don Johnson and Mrs. Daryl Dell had charge of the program. The next meeting will be in the home of Mrs. Stanley Morris.

Pre-Nuptial Dinner To Honor Dorothy Reinhardt
 Mr. and Mrs. Emil Reinhardt will entertain at a pre-nuptial buffet dinner at their home Saturday for Dorothy Reinhardt and Roy Radloff, Fremont, who will be married Sunday at Trinity Lutheran church, Fremont. Guests will include Mr. and Mrs. Tolson R. Radloff, Mr. and Mrs. Frank Johnson and son, Mrs. Mayon Spence, Lindoh Park, Mich., Mrs. Fred Radloff, Romulus, Mich., Rev. and Mrs. J. H. M. Sherry and family, Jacksonville, Pa., Mr. and Mrs. Leslie Younmyer and family and Mr. and Mrs. Merlin Reinhardt and family, Wayne.

Schrank's
 Portofino Pajama
 Fashion Inspired at the Famous Italian Resort
 Red and navy stripes on white ground. Red knit Continental neckline. All red tapered pants.
 YOU'LL LOVE THEM! Wear them for sleeping, lounging or TV viewing.
 A Perfect Gift or for Yourself
 Sizes 32 - 40
 6.98
 A Choice Selection of Warm Pajamas and Gowns
 Styled by Schrank and Luxite at . . . 3.98

Glo Candles Made at Happy Homemakers
 Happy Homemakers met Thursday in the home of Mrs. Preston Roggenbach. Mrs. Wolverson, Stanton, gave a demonstration on making glo candles. Mrs. Bernard Splitgerber started on the second series on landscaping. Guests were Mrs. Charles Roggenbach, LaVerne, Calif., Mrs. Anton Pflueger, Mrs. Robert Roggenbach, Mrs. Gene Wolverson and Myrtle Anderson. Next meeting will be a family Christmas party in the REA building.

Presbyterian Women Hold Family Dinner
 Presbyterian Women's afternoon and evening circles met for a joint family dinner party last Wednesday evening. Rev. O. B. Proett gave devotions and showed two films, "India" and "The American Indian." Reports were given by the nominating committees of both groups. Financial reports were given on the father-son banquet. Next meeting will be a Christmas party.

Eighteen Couples Attend Redeemer 79'er Club
 Redeemer 79'ers met Sunday in the church parlors with 18 couples attending. It is planned to meet on the first Sunday of the month instead of the third Sunday. Program leaders were Mr. and Mrs. Dean Pierson and Mr. and Mrs. August Witter. Hosts were Rev. and Mrs. S. K. de Freese and Mr. and Mrs. Rowan Wiltse. Next meeting will be Dec. 4.

WEDDINGS
Mrs. Peggy Sund Weds Dr. Gormley
 Mrs. Peggy Sund and Dr. R. E. Gormley were married Sunday afternoon in the home of the bride's uncle and aunt, Mr. and Mrs. Scott Wall, Fremont. Rev. S. K. de Freese, Wayne, performed the ceremony.
 Matron of honor was Mrs. B. Wall, Fremont. Best man was B. Wall, Fremont.
 After a 10-day trip to the West Coast, visits with the Dick Sund family, Centralia, Wash., and Dr. Gormley's sister, Mrs. Roger Harris, Butte Falls, Ore., the couple will be at home at 921 Pearl street, Wayne.

Donna Mae Gubbels And James D. Lackas Wed In Randolph
 Randolph—Donna Mae Gubbels, daughter of Mr. and Mrs. Walter Gubbels, and James D. Lackas, son of Mr. and Mrs. Edwin Lackas, were married last Wednesday

The Wayne (Nebr.) Herald, Thursday, November 24, 1955

morning in St. Frances Catholic church. Rev. Raymond Auer performed the double ring ceremony. The bride, given in marriage by her father, wore a gown of chantilly lace and nylon tulle fashioned with a lace bodice and floor length skirt. Her long sleeves were tapered to points at the wrists. The bouffant skirt fell into points of matching lace with rows of ruffled nylon tulle. Her fingertip veil of silk illusion fell from a high coronet of sequins.
 Matron of honor was Mrs. Robert Tunik. Her gown was of emerald green crystalite over taffeta with a full floor length skirt. Her matching headband was trimmed with seed pearls. She carried a bouquet of gold carnations.
 Patty Lackas, sister of the bridegroom, was bridesmaid. Her gown was identical to the matron of honor's.
 Walter Gubbels Jr. was best man. Don Cunningham was groomsmen. Ushers were Richard Gubbels and Larry Lackas.
 Mother of the bride wore a raspberry crepe dress. The bridegroom's mother wore a turquoise crepe dress. Both wore pink carnation corsages.
 A dinner for the immediate family was held at the home of the bride. The wedding cake was baked and decorated by Mrs. Lloyd Dunklau, Mrs. Marvin Mann and Mrs. Joe Hinkle.
 The bride graduated from St. Frances in 1954 and has been employed in the Wayne telephone office. The bridegroom graduated from Randolph high school in 1954 and is now in the Navy.

USE WAYNE HERALD WANT ADS
REPORT YOUR NEWS!
PHONE 130

Swans' For Your Important Holiday Dates

18.98

Bobbie Brooks adds a new look to the princess fashion

Here's a brilliant fashion for those important hours when you want to look your best. The flattering princess line... accented with a jaunty wing collar... and sparkling with its glistening bands of beauty all around. Wide ribbed rayon and cotton in heavenly colors. Sizes 5 to 15.

75 Better Dresses
 All Wool Jerseys
 Winter Cottons
 Velvetines
 Orlon - Rayon Mixtures
 New Dresses!
 New Fabrics!
 All Sizes 9-15, 12-20, 14 1/2-22 1/2
 Values to 22.95
 12.98
 SELECT THAT HOLIDAY DRESS NOW AT SUBSTANTIAL SAVINGS!

Give Samsonite Luggage

NEW! the amazing fingertip-light luggage

Ultralite Samsonite Luggage

made with Dow Hagedrom

Four beautiful "better-than-leather" finishes for women, three handsome finishes in men's cases.

Ladies' O'Nite Case \$25
 Men's Quick-Tripper \$25
 All prices plus existing taxes

Streamlite Samsonite Luggage

Exclusive Streamlite Samsonite Advantages!

1. Its unique new tongue-in-groove construction guards your things against dust and dampness!
2. Six better-than-leather finishes resist scuffs and stains—shine like new with a swish of a cloth!
3. Holds more clothes in less space—wrinkle-free!
4. Modern, non-tarnishing brass latches!

Choose from Our Complete Stock. All Styles in 6 Glamorous Finishes

WE'RE OPEN NIGHTS DATES SHOWN IN BLACK

Su	Mo	Tu	We	Th	Fr	Sa
					1	2
4	5	6	7	8	9	10
11	12	13	14	15	16	17
18	19	20	21	22	23	24
25	26	27	28	29	30	31

CHILDREN Be Sure to Ask for FREE TRAIN RIDE TICKETS for NOV. 25 - 26

SWANS' Apparell for Women

Thanksgiving... at Your House



Mr. and Mrs. Charles Millie are entertaining Mr. and Mrs. Dean McClary and Wendie Ponca. Dinner guests in the Mrs. Mae Young home are Mr. and Mrs. David Young and family, Concordia, Kan., Mr. and Mrs. William Nelson and family, Columbus, and Mr. and Mrs. F. J. Nelson, Sioux City.

Mr. and Mrs. Paul Zeplin are visiting in the Albert Kortje and Mrs. Ernestine Zeplin homes, Norfolk.

Mr. and Mrs. Claude Wright and son, Robert Wright and family, Mankato, Minn., are spending the day with Mrs. Robert Wright's parents, Mr. and Mrs. Harold Sherry, Wakefield.

Guests in the Maunso Ulrich home are Mr. and Mrs. August H. Wittler and Mr. and Mrs. Walter Ulrich.

Mr. and Mrs. M. W. Willert, Yankton, and Sharon Willert, Lincoln, are visiting Mr. and Mrs. E. W. Willert and family.

Mr. and Mrs. Frank Rees are spending the day with Mr. and Mrs. Clyde Waits.

Mr. and Mrs. Warren Damme are visiting in the George Welch home.

Mr. and Mrs. Henry Wehrlich, Randolph, are calling in the Marvin Wehrlich home.

Guests in the Dwayne VanAuer home are the Lee, Wayne, Grant, Alvin and Don Diegen families. Mr. and Mrs. Hans Tietgen, Mr. and Mrs. Emil Diegen, and Mr. and Mrs. Melvin Ehrhardt and family.

Mr. and Mrs. Fred Meyer are visiting in the Reuben Meyer home.

Mr. and Mrs. Merlin Meyer are spending the day with Mr. and Mrs. Leo Stafford, Decatur.

Mr. and Mrs. Jack Miller and family are guests in the Harvey Marwood home, Clearwater.

Dinner guests in the George Sherry home are Mr. and Mrs. Dan Sherry, Mr. and Mrs. Orville Sherry and Mr. and Mrs. Louis Schmiets, Royal.

Mr. and Mrs. Brad Warnemunde and Mrs. V. A. Senter are dining in the R. M. Carhart home.

Mr. and Mrs. Leslie Sherman, Mrs. Opal Schultz and Jim Birdsong are dinner guests in the Myron Schultz home. Mr. and Mrs. Vernon Schultz will call in the afternoon.

Mr. and Mrs. Don Wightman are entertaining Mr. and Mrs. Gene Deeter and family, Lincoln, Mr. and Mrs. Ed Smith, Mr. and Mrs. E. Nyberg, Mr. and Mrs. Edward Witt and family and Mrs. F. N. Nyberg.

Dinner guests in the Cecil Wriedt home are Mr. and Mrs. Ezra Boeckenhauer, Mr. and Mrs. Robert Boeckenhauer and family, Mrs. Mert Wriedt and family, Emerson, Mr. and Mrs. Lester Wriedt, Jefferson, S. D., Mr. and Mrs. W. A. Barrett and Mr. and Mrs. Stewart Klatt, Grand Island.

Mr. and Mrs. Alvin Voorhies and family are visiting in the S. D. Ringenbier home, Plainville.

Mr. and Mrs. Ed Tietgen and family are spending the day with Mr. and Mrs. Norbert Husman, Pilger.

Guests in the Merle Tietgen home are Mr. and Mrs. Perry Ping, Sioux City, and Mr. and Mrs. Earl Fish and boys, Eldon.

Mr. and Mrs. Robert Rinehart are visiting Mr. and Mrs. John Sass, West Point.

Visitors in the Vernon Miller home, Wesside, are Mr. and Mrs. Harry Swinney, Mr. and Mrs. Walter Boyer and family and Mr. and Mrs. William Campion, Ogallala.

Mr. and Mrs. Alfred Sydow are guests in the Merle Sydow home, Grand Island.

Mr. and Mrs. Ed Meyer, Mr. and Mrs. Ben Ahlbers and family are spending the day and dining in the Melvin Meyers home.

Mr. and Mrs. Adon Jeffrey and family are dining in the Orson Jeffrey home, Plainville.

Mrs. Alex Jeffrey is entertaining Mr. and Mrs. Robert Jeffrey, Mr. and Mrs. Edward Sampson and family and Mr. and Mrs. Walter Johnson and family are calling in the Mrs. Henry Hinnerichs home.

Cooperative dinner guests in the Mrs. Amelia Lessmann home are Mr. and Mrs. Robert R. Johnson and Mary, Mr. and Mrs. Merle Lessmann and family, Mr. and Mrs. Willis Lessmann and family and Mrs. Dorothy Parenti.

Mr. and Mrs. Henry Reeg are entertaining Mr. and Mrs. Herman Reeg.

Mr. and Mrs. Fred Reeg are dining in the Florenz Nieman home.

Mr. and Mrs. John Ratzlaff and family are visiting in the W. J. Cartwright home, Brook.

Mr. and Mrs. Ted Reeg are spending the day in the Ed Reeg home, Colome, S. D.

Guests in the Mercedes Reeg home, Fremont, are Mr. and Mrs. Keith Reeg, Mr. and Mrs. Roscoe Jones and family, Mrs. Iva Reeg and family, and Mrs. Sioux City.

Mr. and Mrs. A. C. Norton are entertaining Mr. and Mrs. Oscar Swanson and Janice, Mr. and Mrs. Bob Bodenstedt, Carroll, and George Jaeger, Wesside.

Mr. and Mrs. Leonard Olson are spending the day with Mrs. Esther Kennedy, Newman Grove.

Mr. and Mrs. Albert Morlock are visiting Mr. and Mrs. Richard Morlock, Columbus.

Guests in the John Bessler home are Mr. and Mrs. John Cavomb, W. E. VonSeggen and John VonSeggen.

Mr. and Mrs. Harold McDermott, Holstein, Ia., are dining in the Charles McDermott home.

Mr. and Mrs. R. E. McGinn and family are visiting in the Mrs. Lillian McGinn home, Plainville.

Mr. and Mrs. Harry McGinn are visiting in the Don Jukin home, Hartington.

Visitors in the Keith Aaberg home, Stanton, are Mr. and Mrs. Earl Aaberg.

Mr. and Mrs. Lloyd Russell and family are spending the day with Mr. and Mrs. George Reed and family, Lincoln, are dining in the M. C. Russell home.

Dinner guests in the S. E. Samuelson home are Maj. and Mrs. Dale Samuelson and Mrs. Carl and Mrs. M. J. Johnson.

Mr. and Mrs. Don Johnson are entertaining Mr. and Mrs. Fred Roebler, Mr. and Mrs. Gerald Becker and David, Mr. and Mrs. Lloyd Roebler, Bruce and Byron and Mr. and Mrs. Milton Roebler, Mike and Mark, Allent.

Mr. and Mrs. Hans Rehwisch are having dinner at the home of Dr. and Mrs. Lyle Strunk.

Marlan Carlson came Tuesday evening to spend Thanksgiving vacation with his parents, Mr. and Mrs. Albert G. Carlson. He will return to University of Kansas Monday.

Mr. and Mrs. Hattie McNutt, Mr. and Mrs. Emil Dion and Dick and Mr. and Mrs. Don Dion and Kerry Lee, Columbus, are having dinner at the McNutt home.

Brenna

By Staff Correspondent

The following items were prepared for publication last week.

Mr. and Mrs. Henry Koch and Leiland spent Sunday evening in the Alvin Reeg home. Monday evening visitors were Mr. and Mrs. Herbert Gerleimann and Joan. Sunday dinner guests in their home were Mrs. Katie Reeg and Emilie, Rev. Raymond Kiasing and Mr. and Mrs. Fred Reeg.

Mr. and Mrs. Gilbert Danberg and family and Mr. and Mrs. Ray Gamble visited in the home of Mr. and Mrs. Albert Gamble last Friday evening.

Visitors in the Louis Test home last Sunday evening were Mr. and Mrs. August Brudigan, Mr. and Mrs. William Vahlkamp visited in their home last Tuesday evening.

Mr. and Mrs. Carl Mellick were visitors in the home of Mr. and Mrs. Glenn Haines, Lincoln, last Sunday.

Last Sunday guests in the Russell Lindsay home were Mr. and Mrs. Don Milliken and Mr. and Mrs. Morris Lindsay.

Mr. and Mrs. Thayne Woodward were last Sunday dinner guests in the home of Mrs. Charles Baird.

News of Wayne Churches

Redeemer Lutheran Church ULC (S. K. de Fresco, pastor) Saturday, Nov. 26: Junior choir, 1:30 p.m.; confirmation class, 2 p.m. Sunday, Nov. 27: Early service, "Come Lord Jesus" 9 a.m.; Sunday school, 10; late service, 11. Monday, Nov. 28: Mission study group, 8 p.m. Thursday, Dec. 1: Ladies aid, 2 p.m.

Church of Christ (A. Paul Cook, pastor) Sunday, Nov. 27: "The Living Word," 8 a.m.; Bible school, 10; worship "Acceptable To God," and special music following the Lord's supper, 10:55; CYP meeting, 7 p.m.; evening service, "Grace Upon The Humble," singsgiving scripturing, youth special (Marlyn and Mark Stricker, jr.), 8. Wednesday, Nov. 30: Senior choir practice, 1 p.m.; prayer meeting and Rooster club, 8; meeting in Grace study, 8:30.

Theophilus Evan. & Ref. Church (Raymond W. F. Kiasing, pastor) Thursday, Nov. 24: Thanksgiving choir practice, 9:30 a.m.; Friday, Nov. 25: Confirmation class, 4 p.m. Sunday, Nov. 27: Sunday school, 9:30 a.m.; service, 10:30.

First Methodist Church (A. B. Gray, pastor) Thursday, Nov. 24: Union Thanksgiving service, Rev. Russell M. Daeken, "Christ, The Source of All Riches," 9 a.m. Saturday, Children's choir, 2 p.m. Sunday, Nov. 27: Wesley foundation coffee hour, 9:30 a.m.; Sunday school, 9:45; morning worship, "Seven Aspects of Man," 10:55; nursery for pre-school children, 10:55.

Trinity Lutheran Church, Altona Thursday, Nov. 24: Thanksgiving service, 10 a.m. Sunday, Nov. 27: Divine service, 10 a.m.

Want Ads

Livestock

FOR SALE: Duroc boars. Purple ribbon winners. Located 10 1/2 miles south of Wayne on Hwy 15. Arnold Stuthman and Sons, Wisnor.

FOR SALE: Choice quality purebred Hampshire boars. Big and rugged with extra length. Meat type. Alfred Hansen, 5 miles west, 4 south and 1/2 west of Plainville.

FOR SALE: Purebred Hampshire boars and gilts. I showed grand champion boar and sow at Wayne fair this fall. Jarrell Hampshire Farm, 1 west, 1 1/2 north of Carroll.

PUREBRED Duroc boars and gilts. Meat type. New blood lines. 7 west Wayne, 1 1/2 north, Robert Erwin, Carroll.

FOR SALE: Purebred Registered Hampshire boars. 3 west 2 1/2 north Wayne or 4 east, 1/2 south Carroll. Henry Haase and Sons.

FOR SALE: Purebred Duroc boars, meat type. Priced reasonable. 11 miles south, 1 1/2 west Wayne. Henry Stuthman, jr. 0131f

FOR SALE: Hampshire boars; purebred for long meaty, quick growth profits. Double vaccinated. Willard Maas, 1 1/2 north Hoskins, Phone 1213.

FOR SALE: Purebred Hampshire boars. Cholera immune. Pedigrees available. Guaranteed breeders. Phone AT 7-2797. Eugene Packer, 5 north, 3 east Wayne. 02016p

Choice HOLSTEIN Springing COWS and HEIFERS. Also Heifer calves, bangs vaccinated or tested. GERALD HICKS Winside n101f

FOR SALE: Purebred Hampshire boars. Two miles west of Hartington on Highway 84. Burbach's Hamp Farm. n316

FOR SALE: Hampshire boars. Also a few fall boars. Double vaccinated. Guaranteed and delivered. Gerald Stoltenberg, 17 west, 2 north, 1/2 west Wayne. 0271f

FOR SALE: Registered Spotted Poland China boars. Long bodied meat type, with fast growing and feeding qualities. Henry Klopp, Wayne. 02716p

FOR SALE: Purebred Yorkshire boars. 10 miles northeast Wayne. Dwayne Erickson. n2413

FOR SALE: Big type Poland China meat type spring boars. New blood lines for old customers. Albert J. Hingst, Emerson, phone 7042. n1712D8

FOR SALE: Large four- and five-boys. Bred to Yorkshire home farrow in February. Wakefield, Ala. 7-2971. n211f

BOARS FOR SALE: Big rugged meat-type purebred Spotted Poland China and Hampshire boars. 3 miles north and 1 1/2 west of Laurel on highway 15. Phone 6-3217. Elmer Hattig. n1018

PUREBRED Hampshire boars and gilts. Champion stock. \$60.00 will buy choice of boars if bought this week. Jarrell Hampshire Farm, Carroll. n013p

FOR SALE: Top quality meat type Hampshire purebred spring and fall boars. Vaccinated for cholera and erysipelas. Herbert Albers, 6 1/2 miles north Wisnor on Highway 51. n1019

FOR SALE: Registered Chester White boars, 3 miles north, 2 west of Wakefield. Phone Atlas 7-2313. n1018

READ THE HERALD EVERY WEEK

AUCTION

IMPROVED 80 ACRES

Cuming County Land

(Owner: Hattie Smidt Beerbohm Estate)

Thursday, Dec. 8

Two p.m. at West door of Courthouse in West Point

DESCRIPTION: SE 1/4 SE 1/4 Sec. 19 & NE 1/4 NE 1/4 Sec. 30-24-4 in Cuming County, Nebr. TENANT: Otto Winkelmann. LOCATED: 3/4 mile North and three-fourths mile East of Highway 275 and 15 Intersection to Wayne-Wisnor-Norfolk.

GENERAL FACTS: Land level to rolling. About 64 acres fine cultivated land. Suitable buildings, REA, WELL.

TERMS OF SALE: 20% cash day of sale and balance due in 60 days on delivery Executor's deed. Abstract furnished. Sold free of encumbrance with 1954 and prior taxes paid. Will of deceased grants Executor full power to sell land. POSSESSION March 1, 1956.

JOHN F. BEERBOHM, Executor
Wissner
BECKENHAUER & BECKENHAUER, Attorneys
West Point, Nebr. n2412

'I See by The Herald'

Items about Wayne folks you know

Alan Martin, O'Neill, visited Mrs. F. S. Berry and Arthur Auker Tuesday.

Guests at the Arthur Auker home Tuesday night to observe Mrs. Auker's birthday were Mr. and Mrs. James Mattison, Emerson, Mr. and Mrs. Wesley Benson, Mr. and Mrs. Harold Quinn, Mr. and Mrs. Don Quinn, Mr. and Mrs. Ben Beneshoff, Mr. and Mrs. Mark Beneshoff and Wilbur Beneshoff, Winside, and Lavonne Vahlkamp.

Sunday dinner guests in the W. C. West home were Mr. and Mrs. Walter Ulrich.

Mr. and Mrs. George Welch, Mr. and Mrs. Warren Damme and Mr. and Mrs. Dale Thieroff and family visited Mr. and Mrs. Jorgen Jorgenson Sunday.

E. W. Willert attended a meeting of school administrators Friday in Lincoln.

Orvid Owens was a dinner guest in the E. W. Willert home Monday evening.

Mrs. G. W. Hughes plans to accompany her son, Burrell Hughes and family to Dallas, Tex. Friday. She will spend the winter in the Burrell Hughes home.

Mrs. Mary Schulte entertained friends and relatives Friday evening in honor of her birthday.

Last Sunday Mr. and Mrs. Lee Brier and family visited in the Myron Schultz home.

Mr. and Mrs. Edward Seymour spent the weekend in the Melvin Seymour home Iowa.

Last Monday Mr. and Mrs. V. A. Marso, Pierre, S.D., were overnight guests in the Dan Stehry home.

Mrs. Alma Steele, Emerson, and Ella Hanson, Council Bluffs, visited in the Art Storm home last week.

Sunday guests in the Art Storm home were Mr. and Mrs. Vern Storm and daughter.

Mr. and Mrs. Alfred Sydow entertained a few friends at cards Friday evening. Mr. and Mrs. F. J. Moses, Tom Roberts, Mrs. James

Wesleyan Methodist Church (M. H. Budensiek, pastor) Sunday, Nov. 27: Sunday school, 10 a.m.; worship, 11; youth Bible study, 7:30 p.m.; evening gospel hour, 8.

Wednesday, Nov. 30: Bible study and prayer meeting, 8 p.m.

First Presbyterian Church (Oliver B. Proett, pastor) Sunday, Nov. 27: Church school, 9:45; nursery, 11; worship service, "Playing Fair With God," special music, 11; Christian education committee, 4 p.m. Wednesday, Nov. 30: High School Westminster fellowship, 7 p.m.

Don't need it? SELL IT THROUGH THE WANT ADS

Lady look first at the MAYTAG automatic washer

Kugler Electric Co.
Phone 322 Wayne
Expert Washer Service with Genuine Maytag Parts

Hallmark Cards
"If You Care Enough to Send the Very Best"

WAYNE BOOK STORE

Near Carroll

SW 1/4 18-27-2, improved SE 1/4 8-27-2, bare
W 1/2 13-27-1, improved S 1/2 NW 1/4 30-27-2, bare
SW 1/4 9-27-2, improved

Near Winside

N 1/2 NW 1/4 31-25-3, bare S 1/2 NW 1/4 27-25-3, bare

Near Sholes

SE 1/4 8-27-1, bare

Please contact Hatfield Farm Mgt. Co., W. R. Nowlen, 306 Ins. Exch. Bldg., Sioux City, or phone 85966 or submit written offer to this office on any of above tracts.

Hatfield Farm Mgt. Co.

Sioux City, Iowa n171d

WANTED -- 2 BOYS

who want to earn extra money for that bike... basketball... Christmas presents or other expenses.

You can earn high profits for these and many other things you want delivering NORFOLK DAILY NEWS routes in Wayne. No Sunday deliveries... only a few minutes each evening.

If you want to start earning your own money now, leave your name and telephone number at The Wayne Herald office. n171d

THIS YEAR

Choose A Gift For The Home!

Here Are a Few Suggestions:

- Living Room Sets
- Hide-a-Beds
- New Modern Lamps
- Occasional Chairs
- Wrought Iron Accessories
- Dining Room Sets
- Breakfast Sets
- Platform Rockers
- Hassocks

The Whole Family Will Enjoy A Gift for The Home

CHILDREN ASK FOR FREE TRAIN RIDE TICKETS ON LITTLE TRAIN HERE FRIDAY - SATURDAY, November 25 - 26

McCullough Furniture Co.

Wayne, Nebr.

OFF INSURANCE COSTS

You can save up to 30% immediately on the cost of passenger auto insurance from Farmers Insurance Exchange--and get an extra 10% discount if you haven't made a claim for 12 months!

NEARLY 2,000,000 POLICYHOLDERS OVER \$141,000,000 IN ASSETS

FARMERS INSURANCE GROUP
Symbol of Superior Service

AUTO, TRUCK, FIRE, LIFE--ALL your insurance needs

CHRIS BARGHOLZ

Box 22 Phone 888-W 107 W. 2nd
Wayne, Nebr.

For More Dollars - Less Shrink - Best Results.

SHIP YOUR LIVESTOCK TO THE SIOUX CITY CENTRAL PUBLIC MARKET

"LAUGHING BOY"
With his smile of joy went to the Sioux City Public Market and was sold competitively at a price determined by the competition of many buyers.

"FOOLISH LAD"
With face so sad, stayed at home and his weight determined the selling price.

MAKE YOUR CHOICE OF FIRMS

STEELE-SIMAN & COMPANY

Sioux City, Iowa

FARM LOANS 4%
National Farm Loan Ass'n.
Member
Federal Land Bank System
Felix Jelinek, Wakefield
A. T. Cavanaugh, Wayne

Wolske Goodwill USED CARS

1955 OLDSMOBILE
Only 2,700 miles on this black and white Holiday hardtop. Here's new car value at used car price in a car you'll have to break at yet.

1954 FORD
A low-mileage one-owner Veteran hardtop with new tires.

1953 STUDEBAKER
An easy handling Champion, 4-door with economical over-drive, has radio, heater, good tires. Try it and you'll like it.

1953 KAISER
A car that has had good care. This 4-door Manhattan is two-tone green with dual range Hydra-Matic transmission. Real car value.

1951 CHEVROLET
Here's that good second car or school car you've wanted. A 2-door with radio, heater, good tires. You'll like it.

1950 FORD
This one shows good care. A 2-door with radio, heater, dual pipes. Two-tone green paint.

1952 JEEP PICKUP
Only 11,000 miles on this 4-wheel drive 1-ton pickup.

1950 JEEP Sta. Wagon
4-wheel drive with comfort.

Pontiac — Cadillac
GMC — Willys
Sales and Service

Wolske Auto Service

Phone 95 Wayne

HERVALE FARMS Polled Herefords

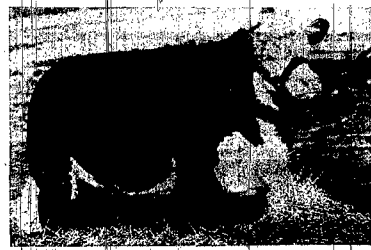

Selling 65 Head

18 Bulls 47 Females
including some club calf prospects

Monday, Dec. 5
12:30 p.m. at the farm
2 miles north, 3 east and 1/4 south of Wayne

For Sale

FOR SALE: Crib size bunk beds with mattresses. \$25. Wakefield Atlas 7-2971. n177f

FOR SALE: Ducks and geese, 4 ml. north, 2 1/2 east Carroll. Mrs. Dick Bethune. n1913

PICTURE frames made to order. Ben's Paint and Wallpaper, Wayne. n2413

TYPEWRITERS: All popular makes from \$79.50. Only \$5.00 down. Wayne Book Store. m311f

FOR SALE: 8 stacks 1st, 2nd, 3rd cutting alfalfa. Dale Pearson, 6 north, 1 1/2 east Wayne. n1013p

FOR SALE: Good quality Minnesota shelled corn. Delivered. Call George Ndash, 2765 Norfolk. n2413

FOR SALE: Alfalfa hay, 2 stacks. Edward Meier. n1713p

M-O-LENE cleaner restores color and lustre to rugs, upholstery, drapes, clothing. Ben's Paint and Wallpaper. n2413

FOR SALE: 1953 Chevrolet. Excellent condition. Gerald Grone, 2 north, 2 1/2 west of Wayne. n1013p

FABSPRAY puts new color back in fabrics. Hundreds of uses for home, auto, industry. 14 colors. Bal fabric cleaner. Ben's Paint and Wallpaper, Wayne. n1913

FOR SALE: Used parts for late model cars and trucks. Wayne Auto Salvage. n1013

For Rent

FOR RENT: 7-room house at 608 Logan. Dick Hansen. Phone 719-3. n2411p

Wanted

WANTED: Scrap iron. Wayne Auto Salvage. n1013

WANT TO BUY: We will guarantee you at least 50¢ a dozen for eggs the year around for Chemell Hatchery's production program in Northeast Nebraska. For details call or write Wayne Foods Co., phone 250, Wayne. e201f

WANTED

WANTED: Muskrat - Raccoon Hides - Sheep Pelts - Wool Rabbit Skins - Horse Hair
Highest Market Prices
Quick Returns
Ship Direct To
W. H. Sturges Co.
27th & "N" St., So. Omaha, Nebr.
Plenty of Free Parking Space

WANTED: Poultry raisers to furnish us eggs at 50 cents a dozen on minimum price the year around. For details on this amazing plan, write or call Wayne Foods company, phone 250, Wayne. e201f

Miscellaneous Services

— Excavating Services —
Septic Tanks and Sewer Lines
JEEP Trenching
Cesspools — Basements
Tiled Wells — Lime Unloading
Bulldozing — Dragline

Neely & Askwith
Phone 52
TILDEN, NEBR.

MEDICAL BILLS

Emergencies play no favorites. Come to us with your problems. Solve them with a confidential loan from the Central Finance Corporation. Borrow on your car or household furniture. Borrow at the...

Private offices - Friendly service
Central Finance Corporation
417 Norfolk Ave. Telephone 350
Norfolk, Nebraska

THE WAYNE HERALD
ON SALE AT
MORRISON HOTEL
FELDER PHARMACY
GRIESS DRUG
COUNCIL OAK

HOME LOANS at 5%

Cavanaugh
323 Main St. a117f

MAKE YOUR MONEY WORK HARD!

Open a Savings account at Home Federal where the current rate is 3%. All accounts insured to \$10,000 by an agency of the government! Write for our Save and Mail Kit.

Home Federal Savings and Loan
700 Pierce Street
Sioux City, Iowa 661

Real Estate

FOR SALE: Improved, exceptionally nice laying quarter located south of Wakefield in Leshe precinct. Price \$250,000. Ringer Agency, Wayne. n1713

120 Acres - Unimproved
Aftona

A good piece of land with some burns to spray. Very good investment.

80 Acres - Improved

Adjoins the above 120 on the West. Fair buildings that can be reasonably be made better. Excellent land.

200 Acres - North of
Carroll

Very choice home, fully modern, good outbuildings, and good dirt. This is Marshall soil, 160 acres rolling and 40 acres level. WE WILL SUBMIT AN OFFER OF \$175 PER ACRE ON THIS FARM. IT IS A BARGAIN.

R.C. Hill Co.

108 West 3rd Wayne, Nebr.
635 Grain Exch. Bldg., Omaha

FARMS FOR SALE: 156 acre-improved farm located 3 miles east of Laurel on Highway 117, 1 mile north, 1 mile east; land lays well; crib and granary good; balance of buildings good for salvage only. 148 acre improved farm located 1 mile west of Belden on Highway 20. All but 10 acres is good bottom land; modern house; other buildings good to serviceable. Both farms priced reasonable; financing arranged to suit buyer. Write or call R. A. Bridenbaugh, National Farms Co., Hartington. n1713

NEED SOMETHING? WE WANT ADS

FARM SALES

The sale season is on in full swing and we invite you to attend the following auctions coming up soon.

- NOV. 28—Ben Benschopf. 1 mile east and 3/4 mile north of Winside. Selling 160-acre farm and personal property.
- NOV. 29—Harry Beckner. 2 1/4 miles east of Carroll. Selling all livestock and farming equipment.
- NOV. 30—Art Neitzke estate. A big sale northeast of Stanton.
- DEC. 5—Gaylerd Wescher. A good sale with good milk cows. North of Stanton.
- DEC. 6—Raymond Maas. 7/4 miles north of Hoskins. A lot of good machinery.
- DEC. 7—Howard Darr. A lot of good machinery, hay and grain. Near Stanton.
- DEC. 8—Otto Carsten. 1 mile east and 1 1/4 south of Winside. Going into business and selling everything including a lot of good feeder pigs.
- DEC. 12—Roy Stender. 3 miles east and 1 1/2 south of Winside. Moving to town and selling all livestock and farming equipment.

FOR A GOOD SNAPPY AUCTION THAT ADDS UP TO MORE DOLLARS FOR YOU, LET US WORK YOUR FARM SALE

Troutman Bros. Auctioneers

Jim Troutman Winside, Phone 2716
Verne Troutman Stanton, Phone 123

FOR SALE: 2 1/2 acre tract in southwest part of Wayne. Partly modern 5 room home. Price \$4,700.00. Possession anytime. Ringer Agency, Wayne. n1713

FOR SALE: Choice lots available in Pine Heights, Wayne's first new subdivision. Protect your investment by building your new home in an area governed by strict zoning regulations. Elmer Harrison, phone 60 or 166-W. n1713

Cards of Thanks

WE WISH TO THANK our friends, neighbors and relatives for the farewell parties, gifts and visits which we shall always remember. Mr. and Mrs. Kenneth Kraemer and family. nov24p

I WISH TO THANK all my relatives and friends for the flowers, gifts and cards I received during my stay at the hospital and also since I came home. Arthur Young.

I WISH TO THANK my friends and neighbors who remembered me with cards and letters and those who visited me in the Wayne and Sioux City hospitals and since my return home. Edward T. Hall. n24p

WE WISH TO THANK our many friends and relatives who remembered us with cards and gifts and those who visited us while we were in the hospital and since our return home. All your kindnesses were appreciated. Mrs. Russell Hoffman and Brian Lee. n24

For Sale 2

BRAND NEW 3 - BEDROOM Homes in HILLCREST ADDITION

These Houses Are Priced to Sell

SEE L. B. McCLURE Agent, at FIRST NATIONAL BANK. n24t2

Your HOGS Are Worth More at Coryell's

We'll Pay You **\$2.50 PER CWT. OVER MARKET**

Toward the Purchase of any Fine Used Car Listed Below!



How It Works:
Just bring in your scale weights from any recognized market dated Nov. 25-Dec. 3. We'll pay you \$2.50 per hundredweight over the price you received on the purchase of any of these cars listed below. This offer applies only up to the total purchase price of the car of your choice.

Example: You sell 10 butchers averaging 200 pounds for \$11.25 per hundred. You get \$225.00. Bring your check and scale weights to us and we'll pay you \$13.75 per cwt. or \$275.00 toward the purchase of one of these cars.

Now you've no need to worry over low market prices on your hogs. We'll give you \$2.50 per hundred over market price and help you step into one of the fine used cars you've been wanting to buy. Don't miss this opportunity to get more for your hogs. Drop in today. This sale ends Dec. 3.

FINANCING AVAILABLE!

- Low Down Payment
Your old car will usually be enough.
- Up To 21 Months To Pay!

Look At These Low, Low Prices!

- Market Toppers**
- 1951 Chevrolet 4-Door**
Styleline Deluxe with radio, heater and seat covers. Broken in—not broken down! A27A. **\$725**
 - 1953 Ford V-8 4-Door**
Radio and heater. Former owner hated to part with this one. Runs like a top. A88A. **\$1095**
 - 1951 Studebaker 2-Door**
Champion with overdrive, radio and heater. Easy to pay for—ask us. L29B. **\$525**
 - 1950 Mercury 4-Door**
Radio, heater, seat covers, overdrive. Painless payments will make it yours. A42A. **\$545**
 - 1950 Ford V-8 4-Door**
Radio, heater and seat covers. A105B. Here's pep, power and personality. **\$475**
 - 1950 Pontiac 4-Door**
Hydramatic 8-cylinder with radio and heater. A70B. You won't need much cash and this will carry you anywhere. **\$595**
 - 1952 International 3/4-ton Pickup**
B21A. Just about the best value you've ever seen. **\$645**
 - 1949 International 1/2-ton Pickup**
B32A. Overhauled to haul for less. **\$395**
 - 1953 Chevrolet 2-Door**
Bel Air style. Radio and heater. R44. Perky! Has plenty of spark. **\$1045**

- Choice Butchers**
- 1949 Ford V-8 Coupe**
Radio, heater, extra good engine. E3B. Best bet for a busy businessman who wants a second car. **\$225**
 - 1947 Ford V-8 2-Door**
Radio and heater. A10B. Our cars are weather-ready. Why walk? **\$165**
 - 1946 Ford V-8 4-Door**
A100C. Good mechanics will go for this one. Ready to go on and on. **\$135**
 - 1946 Ford V-8 2-Door**
A83B. Just about the best value on our lot. Almost cheaper than walking. **\$125**
 - 1947 Chevrolet Coupe**
A130B. Reconditioned for all conditions. L-o-n-g on service. **\$195**
 - 1947 Ford V-8 4-Door**
Easy to buy — if you get here first. Stop looking — start driving. **\$128**
 - 1949 Studebaker 2-ton Truck**
With 14-ft. box B18C. Doesn't look its age or act it. **\$395**
 - 1951 Chevrolet 1/2-ton Pickup**
EB. Someone else has paid for the repairs. Enjoy years of economy. **\$625**
 - 1947 Oldsmobile 4-Door**
Hydramatic, radio, heater. R35. Roomy and reliable. A youthful car inside and out. **\$195**

If You Don't Raise Hogs You're Still Ahead...
While this ad is directed to the farmers, who as we all know, have actually been losing money on hogs, we will, by the same token, deal with all our fine customers on an equitable basis. These cars are the best stock in Northeast Nebraska. They have all been reduced in price and will be sold as advertised during this sale. We must make room for trade-ins on the fabulous new 1956 Chevrolets and Oldsmobiles, so you're money ahead at these reduced prices.

CORYELL AUTO CO.

Chevrolet - Oldsmobile

112 East Second Wayne Phone 152

24-Game Slate Opens for College Quint Next Week

An ambitious schedule of 24 games in on top for Wayne State's 1955-56 basketball squad, Coach Chuck Obye announced this week. It includes eight non-conference titles and a Christmas tournament plus 14 NCC contests.

The Wildcats will make their initial appearance against Omaha university Dec. 7 and open the home season with Augustana at the city auditorium Dec. 3.

Other non-conference foes include Southern Teachers, Westminster college, Colorado State Teachers and the Christmas tourney at Westmar. The conference season will open here against Kearney Jan. 6.

Obye's initial turnout of 42 candidates included seven lettermen and three products of last year's B squad.

Lettermen are: Erik Radke, Aurelia, Ia.; Kingsley Miner, Sac City, Ia.; Jack Pingel, Hoskins; Harold Smith, Washta, Ia.; Larry Buhl, Newman Grove; Bob Tushla, Atkinson, and Mike Mallette, Uehling, Tushla and Mallette are back after service stints.

Moving up from the B squad are Dennis Anderson, Aurelia, Ia.; Tom Heffner, Castana, Ia. and Dan True, Bloomfield.

Newcomers bidding for regular spots are: Tom Conley, Quimby, Ia.; Max Potts, South Sioux City; Paul Smith, Lyons; Gerald Heuser, Quimby, Ia.; Jim Morgan, Correctionville, Ia.; Lily Lanik, Wahoo; Paul Kitchin, Bloomfield; Galen Marks, Tilden; Dick Guenther, Sioux Falls, S. D., and Bill Brunpound, Bancroft.

Subscribe to The Herald

Sports

Winside to Open '55 Cage Season Tuesday

Winside Wildcats will open their 1955-56 basketball season Tuesday night at Wakefield, Coach Drifnae Bucler said this week.

This year's schedule includes two new teams, Wakefield and Pilger.

The remaining schedule: Dec. 9, Newcastle; 13, Wisner; 16, Crofton; 20, Stanton.

Jan. 3, at Hoskins; 6, at Cedarville; 10, Pilger; 13, Osmond; 20, at Randolph; 27, Carroll.

Feb. 1-3, Winside invitational; 8, Norfolk SH; 10, Wausa; 17, at Wayne Prep.

Three Veterans Boost Hopes of Carroll Coach

Three lettermen are back at Carroll high school this year: as Russell Monteth starts his fourth year as coach of the Panthers.

Carroll opened his season by entertaining Dixon Tuesday night. Monteth's charges will play host to Wyrnot Tuesday night.

Veterans returning are Marvin Eckert, Dennis Hansen and Lynn Jones. Rounding out the starting

quint are Dwaine Volwiler and Gene Rethwisch.

Other squad members are Don Volwiler, Lowell Olson, Leon Voeks, Kurt Rethwisch and Thomas Olson.

Carroll will play in the Northern Eight conference which includes Waterbury, Thurston, Dixon, Concord, Hoskins, Belden and Randolph St. Frances. A conference tournament is scheduled at Carroll Jan. 11-13.

The remaining Panther schedule: Dec. 2, at Concord; 6, at Waterbury; 9, at Belden; 13, Hoskins; 16, Brunswick; 20, at St. Frances; 22, Thurston.

Jan. 11-13, Northern Eight tournament; 20, at Hoskins; 24, Concord; 27, at Winside.

Feb. 10, at Dixon; 14, Belden; 20-25, district tournament.

All home games will start with a preliminary at 7 p.m.

Name Two Prep Men to League All-Star Team

End Roger Anderson and Tackle Don Sherry were named to the Centennial conference all-league team at a meeting of loop coaches last Wednesday at Randolph high school.

Champion Crofton placed six men on the state squad. Winside placed two, Wausa, three, Cedarville two and Osmond two, Randolph and Newcastle failed to land players on the roster.

The complete list: Ends—Keith Stiffen, Crofton; Larry Neff, Crofton; Darrel Barnert, Winside; and Anderson, Crofton. Tackles: Charles Seagren, Wausa; Sherry; John Roberts, Crofton; and Larry Hoffart, Cedarville.

Centers: Barry Kuehn, Crofton; Jim Peters, Wausa; and Roger Kuehn, Osmond.

Backs: Jerry Steffen, Crofton; Don Koch, Winside; Larry Rissler, Crofton; Deaa Specht, Cedarville; Doyle Newquist, Wausa; and Ronald Van Ackenman, Osmond.

Gary Schuttler, Crofton, was named publicity manager for the basketball season. Stanley Westergard, Osmond, presided at the meeting. Third meeting will be held Mar. 6 at Crofton.

Randolph homelec girls, supervised by Lois Porce, served the dinner.

Blue Devils Open Cage Schedule Tuesday Night

Wayne High's Blue Devils will open their 1955-56 basketball schedule at the city auditorium Tuesday night when they play host to Hartington.

Coach Harold Maciejewski has several lettermen returning including Larry Hofeldt and Glenn Houdersheldt from last year's regulars.

Other lettermen who are expected to form the nucleus of the squad are Kenny Dahl, Jerry McGinn, Jerry Hendrickson and Bob Schwartzbach.

Fourteen games are scheduled this winter with eight on the local court. The complete schedule:

Dec. 2, at Tekamah; 9, Norfolk; 16, Plainview; 20, Pierce; 20, Jan. 6, Madison; 13, at Stanton; 20, at Nelich; 24, South Sioux City; 27, Blair.

Feb. 3, at Omaha Poly Name; 7, West Point; 10, Wisner; 14, at Columbus St. Bnaventure.

PHONE YOUR NEWS TO THE HERALD—130

Wayne Bowling

Monday Ladies' League	w	1
Wakefield Recreation	12
N & M Oil	5
Seven Up	10
State Bank	9
Marilyn's Beauty	8
Gene's Cafe	7
Coca Cola	2
Nu Tavern	13
High scores: F. Busby, 187; N. Linder, 434; Recreation, 726; N & M Oil, 1952.		

Wednesday Ladies' League	w	1
Squirt	14
El Rancho	11
McNatt Hdw.	8
Swanson TV	7
Van's	6
Hotel Morrison	5
Dahl Nursing	3
Hill's Lockers	1
High scores: I. Morlok, 159; Morlok, 435; Squirt, 632; Squirt, 1789.		

City League	w	1
Hylne Chicks	13
Gem Cafe	11
Johnson's Bakery	9
Dahl Nursing	7
Hotel Morrison	6
Wolske Auto	6
Seyler Motors	6
Swans	3
High scores: Zart, 203; W. Lessman, 513; Dahl Nursing, 870; Johnson's Bakery, 2274.		

Haskell Farm—

(Continued from page one)

West Point and accepted memberships from Dodge and Pierce counties. Combined contributions from these two counties total about \$1,500.

A committee met Tuesday night in Wayne to set up by-laws for the group.

Northeast Nebraska farmers started the campaign for an experiment farm in this area because none of the present state experiment stations has soil types, climate and growing seasons similar to those found here. Most information received for this area has come out of the Castana, Ia. experiment farm.

Crops-Weather

"'Tis a privilege to live in Wayne"

Moisture continued to avoid Northeast Nebraska this week, but temperatures remained unseasonably cold. Coldest reading was six degrees recorded last Wednesday. High reading was a warm 55 Saturday.

So far this month readings have been much colder than November, 1954. Degree-days for the first 22 days of this month total 737 as compared to degree-day readings of 478 for the same period last November, a difference of 259 degree-days or nearly half again as cold.

Degree-days are a unit used to determine fuel consumption. Degree-days are obtained by subtracting the average mean temperature from 65 degrees.

Herewith — temperatures and precipitation records for the period Wednesday, Nov. 16 through Tuesday, Nov. 22:

Day	H	L	OD	Pre.
Wednesday	20	6	52
Thursday	25	15	45
Friday	20	12	44	tr.
Saturday	55	40	17
Sunday	57	34	19
Monday	50	30	25
Tuesday	40	14	38

Temperatures are recorded 8 a.m. to 8 a.m.

Courthouse Roundup

Marriage Licenses
Nov. 19: Marvin H. Kleensang, 25, Hoskins, and Ione B. Wesley, 19, Hoskins.
Nov. 22: Arnold H. J. Brudigam, Wakefield, and Mrs. Mary L. Hansen, Wakefield.

District Court
Nov. 17: Johanna Luaders Meyer vs. Ernest L. Meyer; divorce proceedings filed.
Nov. 17: Norman L. Willers vs. Carolyn Willers; divorce proceedings filed.

Deeds Filed
Nov. 17: Elnor Cook and wife to Glen H. Martin, Nelson lot 8, except S 4 ft., blk 5, Carroll, for \$2,750.

November Assistance Funds
State: OAS, \$1,853.40; blind, \$73.20; child welfare, \$135; disabled, \$60; administrative, \$349.03.
Federal: OAS, \$2,898.40; blind, \$70; child welfare, \$235; disabled, \$70; administrative, \$172.28.

Business Notes

Sew-Vac Opens
Dick Boyce announced this week he will open a Sew-Vac store Friday in the former location of Russell's grocery. The store will sell sewing machines and home cleaners besides having a service section.

'I See by the Herald'

Mrs. Mae Young and Helen Gildersleeve were Sunday dinner guests in the Harry Radaker home, Wisner.

Seven ladies surprised Mrs. Charles Nichols for her birthday last Thursday afternoon when they brought lunch and spent a social afternoon at her home.

Last Sunday dinner guests in the Archie Wert home were Mr. and Mrs. Donald Milliken.
Mr. and Mrs. Bud Hansen were visitors in the Laurence Backstrom home Friday evening.

Funeral Services Held in Hoskins For Shellenberg

Funeral services for William Shellenberg, 88, Hoskins, who died Nov. 13, 1955 at a rest home in Beemer were held last Tuesday afternoon in the Peace Evangelical Reformed church southwest of Hoskins. Rev. George W. Heusinger officiated.

His survivors include wife, Glenna Vee Wohlsch with Mrs. Andrew Anderson as accompanist. Pallbearers were nephews, Edwin and Dallas Shellenberg, Edwin Brogren, Kenneth and LeRoy Hall and Harlan Herbelshiemer. Burial was in the church cemetery.

William Shellenberg, son of Mr. and Mrs. Carl Shellenberg, was born Apr. 13, 1867 at Barwalde, Germany. He was baptized and confirmed in the Lutheran faith in Germany, where he also received his education. At the age of 18 he and his brother, Charles, came to America. They worked on a farm in Wisconsin until April, 1886 when they came to Wayne county and located on a farm near Hoskins.

Preceding him in death are his parents, five brothers and one sister. Survivors include one brother, Fred, Portland, Ore., three nieces, and four nephews in Wayne county and one in Germany.

NORTHWEST Wakefield

By Mrs. Wallace Ring (Wakefield Atlas 7-2872)

Ervin Bartels and Eugene were Sunday dinner guests at Harry Bartels. Mr. and Mrs. Marvin Roebber, Pender, were supper guests. Mr. and Mrs. Leonard Dersch were evening visitors.

Mrs. Emil Miller and Elton were supper guests of Mr. and Mrs. Robert Anderson and Jim Friday.

Mr. Clarence Walter and Mrs. Lawrence Blatter attended a party at Mrs. Samuel Meske's Thursday afternoon.

Mr. and Mrs. Gerald Becker and David Lee were Friday supper guests at Lloyd Roebber's. The Kermit Turner family were evening guests.

Sunday afternoon Mr. and Mrs. Norman Roebber and Dennis and Mr. and Mrs. Lloyd Roebber and sons visited Niobrara friends.

Mr. Don Denbeck and Debbie spent Sunday afternoon with Mrs. Emil Roebber.

Bill Klein and sons, Battle Creek, were Sunday afternoon visitors at Clarence Wolter's.

Mr. and Mrs. Thure Johnson were in Concord Monday afternoon to attend funeral services for her uncle, Ed Fredrickson.

Mr. and Mrs. G. H. Schnier, Mr. and Mrs. Glenn Cooper and boys, Bancroft, and Mr. and Mrs. Lawrence Johnson and family, Pender, were Thursday evening guests at Ivan Nixon's to help Janja celebrate her eleventh birthday.

Mrs. A. G. Schager was reminded of her birthday when Mrs. Ben Lund, Mrs. Hjalmer Lund, Mrs. Thure Johnson and Mrs. Axel Fredrickson spent Saturday afternoon with her and served birthday lunch. Mr. and Mrs. J. I. Pedersen and family, Laurel, called later.

Too Late To Classify

OUR SINCERE THANKS to all who sent cards, gifts and visited us while in the hospital and after our return home. They were after our appreciation. Mrs. Harry Bargholz and Judy Ann. n24p

Mr. and Mrs. Thure Johnson spent Sunday evening with Mr. and Mrs. Ben Lund.

Cal Swagertys attended the junior class play in Dakota City Friday evening. Her nephew, David Nixon, took part in it.

Mr. and Mrs. Jim Moody, Pender, were Friday dinner guests at Cal Swagertys'.

Mr. and Mrs. Harry Bartels, Mrs. Sophia Walters, Mrs. Lawrence Johnson and Emil Roebber returned Thursday evening from a week's stay in Springfield, Mo. with Mr. and Mrs. Richard Mein.

They report Mrs. Mein able to be up but still confined to the hospital. Mr. Mein is still unconscious following an automobile accident. He has undergone surgery on his head. Mrs. Ervin Bartels and Mrs. Roy Holm went down by train to be with them this week.

Mrs. Clarence Wolter entertained at a lingerie party Friday afternoon.

Evangelist Cy Welch, Footsville, Wis., and Rev. Merlin Wright were Wednesday dinner guests at Kenneth Packers'.

Mr. and Mrs. Cal Swagertys entertained at a fish supper Saturday the Ivan Nixon and Kermit Turner families, joining them for the evening were Mr. and Mrs.

Kenneth Schnier and sons, Pender, Mr. and Mrs. Leon Weddingfield and family, Newcastle and Mr. and Mrs. Clarence Starzl, Emerson.

Ivan Nixon's were Sunday evening visitors at Leo Schulz's.

Mrs. Art Meyers, Mrs. Emil Miller and Mrs. Ernest Packer were last Wednesday dinner guests from Mrs. Della Church, South Sioux City.

Mr. and Mrs. Paul Dahlgren were Sunday evening guests of Mr. and Mrs. E. W. Lundahl.

Mr. and Mrs. Wallace Ring were entertained at Sunday dinner and supper in the Elmer Nelson home. In the evening Mr. and Mrs. Ring visited in the Joe Heckens home, Emerson.

Now in Progress...Tiedtke's

CARLOAD SALE

of Fabulous New 1956 G-E APPLIANCES

YOUR CHOICE OF G-E MIX-OR-MATCH

COLOR

IN THE NEW G-E Filter-Flo Washer and Dryer



MODELS WA-750 WASHER DA-623 DRYER

NOW, choose a G-E Washer and Dryer in colors that make your laundry a decorating asset wherever you place it—in the kitchen, recreation room, hall or even in a bathroom.

You can have this exciting new decorator laundry in thrilling two-tone color combinations of petal pink and cadet blue—or—canary yellow and woodbine brown... or select solid tones for your washer and dryer: turquoise green, canary yellow, petal pink, cadet blue or woodbine brown. Ask about the Mix-or-Match paints available to complete your color scheme.

See The Beautiful G-E Decorator Laundry of your choice AS LOW AS \$500 A WEEK AFTER SMALL DOWN PAYMENT

SPECIAL INTRODUCTORY TRADE-IN ALLOWANCE FOR YOUR OLD WASHER OR DRYER

COLOR ISN'T ALL!

- G-E FILTER-FLO WASHER
- REMOVES LINT
- REMOVES SAND
- REMOVES SOAP SCUM

Authorized Dealer GENERAL ELECTRIC APPLIANCES

See Us Before You Buy!

- AUTOMATIC DRYERS
- RANGES
- WATER HEATERS
- FRYERS
- AUTOMATIC WASHERS
- DISHWASHERS
- DISPOSALS
- REFRIGERATORS

See Them All At... TIEDTKE

108 Main PLUMBING, HEATING & APPLIANCES Phone 268

TILLIE'S SHOPPE

The Different Gift Shop

Handwork • Novelties • Toys
Kitchen Utensils • Costume Jewelry
Ceramics • Books • Games
Cosmetics

WATKINS PRODUCTS

Gifts for Folks from 1 to 80

Come In - Browse Around - New Stocks Arriving Daily

Tillie's Shoppe

319 Main Phone 307

for THE MAN on Your Christmas List

NEW SCHICK "25"

money-back guarantee



New Schick "25" with black and silver Coddie Case

You be the judge! The newest and finest shaver ever made by Schick must give you the closest shaves your face has ever felt or your money back in 14 days!

SPECIAL! \$7.50 Trade-In Allowance for Your Old Electric Shaver

Select Hallmark Gift Wrap and Christmas Cards Now. Fresh Stocks Just In

CHILDREN — ASK FOR FREE TICKETS FOR THE LITTLE TRAIN. HERE NOV. 25 - 26

Two Registered Pharmacists to Serve You

FELBER PHARMACY

RELIABLE PRESCRIPTION SERVICE SINCE 1906

Real Working TOYS for the Playland Farm



JOHN DEERE Toys will make you popular with every boy and girl on your gift list. Little farmers can really "pretend" with these miniature tractors, pickers, loaders, spreaders, plows, harrows, wagons, and combines, because each one has "life-like" moving parts. These toys are strongly-built, authentic reproductions of the real thing. Individually packaged. Stop in soon, while our stock is complete.

Brandstetter Implement

Phone 276 Wayne, Nebr.

Get JOHN DEERE TOYS Today



Expensive Styling
Big Reductions

Better Coats

\$25

Save Now!

Just think of it! Right now with many winter months ahead, you can buy your new winter coat at Larson's during this big bargain days event at big savings. Be sure to shop early Friday for best selection. Every coat 100% pure wool and all linings are guaranteed for two years.

ALL LADIES' COATS REDUCED

Larson's

LARSON KUHN CO.

Bargain Days

Come One! Come All! to Larson's.
Scoop Up All Sorts of Holiday Buys
at Exceptional Early Bird Savings

Bag and Umbrella Ensemble

\$6.95

Here is a gift item that any lady on your list will treasure. Large size utility bag in assorted colors, all with matching umbrella as that fit in the hangers on the side of the bag.

1,000 Rubber Balls

Go on Sale Friday Morning

Bright Colorful

You will be amazed at these big bright colorful inflated rubber balls for only 39c each. You will buy several when you see this outstanding bargain.

39c

Big Savings Prices Reduced

Side Buckler

Value Priced!

\$7.00

"Buy By Comparison"

Here is the practical coat of all coats for girls wearing sizes 7 to 14. Made of water repellent outside shell with removable hood. Warm, fleece lining. Colors in red and navy.

Pure Wool Zephyr Scarves, \$1.98

Clutch BAGS

Be sure to see this outstanding value in our purse department. Several styles of lovely new clutch bags. All going at \$1.00.

\$1.00

plus tax

Sweaters

High Bulk Orlon

SLIPOVER
Lots of ladies' sweaters to choose from and in every one of the season's newest colors. Complete range of sizes from 34 to 40.

\$2.98

CARDIGAN
Here are the matching cardigans in popular bathing style. \$4.95
Sizes 34 to 40.

"Gift Worthy"

Nylons

2 Pairs

"Perfectly Matched"

\$1.59

for 2 pairs!

Here are nylons that are gift worthy for any lady on your list. Two pairs perfectly matched at the factory, packed in a beautiful gift box ready for giving. All sizes and proportionate lengths. Guaranteed first quality. Sheer and beautiful. Fashionable dark seams.

Boys' Flannel Shirts - \$1.98

Romeos

Soft Pliable Leathers

The most comfortable slipper a man can own. These are top quality kid leather romeos, never seen at this low, low price. Shop for these quality shoes today.

\$4.95

Challie Head Squares

Girls'

Orlon Sweaters

High Bulk Yarns

Look at this bargain. Orlon sweaters for girls in popular pull over styles. All colors and all sizes from 3 to 14.

\$1.98

Boys' Fruit-of-the-Loom Shirts - \$1.98

Men's S-T-R-E-T-C-H SOX

Genuine Helanca Yarn

These are genuine Helanca stretch socks. Made in a wide range of beautiful patterns. Lots of solid colors to choose from. One size fits all.

79c - 3 prs. 2.25

More Pull "Big Cuff" Ankle

Fancy

Wool Gloves

Extra Value

Here is extra value to stretch your Christmas budget. 100% pure wool gloves, in sizes to fit the small fry as well as ladies.

\$1.00

Strictly First Quality

Rubber Footwear

A. - 4-Buckle

Dress O' Shoe

Now is the time to stock up on warm rubber footwear. Choose from Larson's big stock of all first quality merchandise. Compare our low prices.

Men's Sizes, 7 to 12 \$4.59
Boys' Sizes, 3 to 6 \$4.39
Youth Sizes, 11 to 2 \$4.19

Boys' 10 1/2-oz. Sanforized

Rail Chief Jeans

Sizes 6 to 16

Compare the quality, compare the fit. You will like Rail Chief jeans for your boy because they wear longer and will wash without shrinking. Heavy 10 1/2-oz. denim.

\$1.49

Ladies' Orlon Shrugs

Off Full Bolts

Pinwale Corduroy

Take a look at this bargain! First quality pinwale corduroy in a wide range of colors. Shop during these big bargain days and save.

2 yds. \$1.50

Wool Stoles, Lurex Yarn - \$1.98

B. - Insulated

Cold Guards

These are the ever popular Cold Guards that are insulated. Ladies' sizes 5 to 10.

\$2.98

Men's Nylon and Wool Surburban Coats

\$9.90

The casual outer coat that's in the style spotlight... short cut for freedom of action. The perfect gift. Choice of colors.

Sizes 40 to 46
Warm Quilted
Earl-Glo Lining

Handy Andy Chore Gloves - .39c

Multi-Stripe

Cannon Towels

We believe this to be the most beautiful towel that Cannon has made in years and years. We have the complete sets consisting of bath, guest, and wash cloths. Ideal gift for the home.

98c

Guest 59c
Wash 29c

Men's Work Shoes - \$5.95

Biggest Show in Town!

Horsman Dolls

Lowest Prices in Years!

\$2.99 to \$9.99

25c Deposit Holds 'Til Dec. 13

Nobody, but nobody but Larson's shows you such a tremendous showing of the genuine Horsman Dolls. Visit our big doll booth and make your selection now at these low bargain day prices. Yes, 25c down will hold your doll until Dec. 15.

Wm. Rogers Silverplate - 50 Pieces

Service for 8
A Celebrated Trademark

- 2 Patterns
- Famous Quality
- Pure Silverplate

\$10.00

Just 50 of these beautiful 50-piece Wm. Rogers silverplate sets to go. Complete service for 8. A traditional quality known for years and years. Buy these at Larson's and save.

The Cabinet Available for\$3.98

The Wayne Herald Way Back When...

Serving Northeast Nebraska's Great Farming Area

10 Main St. Wayne, Nebr. Phone 130

Established in 1875; a newspaper published weekly on Thursday by Mrs. Margaret E. Gramer entered in the postoffice at Wayne, Nebraska, as second class mail matter. Copy must be submitted by preceding afternoon.



Poetry—The Wayne Herald does not feature a literary page and does not have a literary editor. Therefore poetry is not accepted for free publication.

Copyright 1955 by The Wayne Herald, Ed Johnson, Editor. Reproduction in whole or in part strictly forbidden without written consent of The Wayne Herald.

Official Newspaper of the City of Wayne, the County of Wayne and the State of Nebraska

SUBSCRIPTION RATES
In Wayne, Pierce, Cedar, Dixon, Thurston, Cumis, Stanton and Madison counties, \$3.00 per year, \$2.00 for six months, \$1.00 for three months. Outside counties mentioned: \$3.50 per year, \$2.50 for six months, \$1.25 for three months. Single copies 15c.

Keep Thanksgiving Thankful

This issue of The Wayne Herald comes out at Thanksgiving time... a holiday for visiting family and friends, a time for rejoicing, reunion and happiness.

For many of us the holiday will mean long highway trips, some will be one-day jaunts, others will be for a long weekend. Highway will be busy, drivers will be hurrying, driving and road conditions may be bad in some areas.

It will be a perfect setting for a sad Thanksgiving for someone. Just a momentary slacking of vigilance... one attempt to pass improperly, one burst of speed and it will be death for someone. At least one family will have a thankless Thanksgiving because of it.

A few more minutes spent on the road... an hour or two earlier start... waiting a few seconds longer before trying to pass can mean many more years on earth. Start early... drive safely... arrive safely... for a thankful Thanksgiving weekend.

A good many people borrow trouble for the sole purpose of lending it to others.

Way Back When...

30 Years Ago
Nov. 28, 1925: About 50 parents of Boy Scouts in Troop Two responded to the invitation of their sons to be guests for an evening and gathered together in the Methodist church parlors last Friday.

25 Years Ago
Nov. 27, 1930: People are already speculating on the kind of winter we are going to have dished out to us. The prevailing opinion is that it will be mild—the wish perhaps having some influence on the thought or prediction.

20 Years Ago
Nov. 28, 1935: Construction of twin colonial houses on Main street west of the college campus was started last week by S. B. Whitmore who is building the two five-room houses for rent.

15 Years Ago
Nov. 28, 1940: Lloyd Berner, 22, son of Mr. and Mrs. Frank Berner, Pierre, suffered a fracture of jaw Saturday evening when his car and one driven by a man from Broken Bow collided at the corner six miles west of Winside on the Hoskins highway.

10 Years Ago
Nov. 22, 1945: Wayne Chamber of Commerce is working on a proposal to get Boys Town's 100-voice choir to come to Wayne to present a formal concert of Christmas music at the city auditorium.

In Bookland

by Mrs. F. A. Millner City Librarian

THE LIBRARY WILL BE CLOSED TODAY. WE did manage to work up a Thanksgiving day theme for our sandbox in the children's room and put up one poster in the reading room but we have been so busy with Children's Book Week and then, suddenly, it is time to put up the Christmas decorations.

WE ALMOST FEEL LIKE WE HAD HAD Christmas at the library after Book Week! We over since it is our biggest week of the year. It was fun having all the children and their teachers and their enthusiasm makes you forget you are tired and your feet hurt. One thing we heard the children say so often was, "I saw that on TV and I want to check out that book."

CAPITOL NEWS

BY MELVIN PAUL
Nebraska Press Association Statehouse Correspondent

LINCOLN—The advisory State Highway commission meets here Nov. 28 and Governor Anderson says he will grant the group "certain authority" then.

The governor has said the commission should be able to hold public hearings on controversial highway matters and "make decisions that will benefit the state as a whole."

Said the governor: "I want to take the advice of the commission when it holds adequate public hearings on controversial highway affairs."

Under the law, neither governor nor the State Highway department must adhere to advice given by the commission.

Delegation of authority to the commission would eliminate the necessity of the public bypassing the commission and appealing to the governor.

Navigation Network
Nebraska's radio navigation network for private pilots should be fully operative by Dec. 1.

At least that's the hope of State Aeronautics Director James Ramsey. He said stations at McCook, Kearney and Beatrice should be in operation by then.

Primarily, they are navigational devices, but they also provide weather information and help safe flying.

Legislature Good
Procedures used by the Nebraska Legislature in handling bills are looked upon with envy by officials of many states.

That's the word from Sen. John Beaver, Beemer chairman of the Legislative council, research group of the Legislature.

Heintze Wins Suit
A decision generally in favor of former State Treasurer Frank Heintze has been handed down in Lancaster county district court, Lincoln.

The suit was brought by Heintze to determine validity of the distribution law—since changed by the Legislature from the Jan. 1, 1950-Dec. 31, 1954 period.

Cap Davis Retires
Everett Davis, captain of the guard at the state prison, retired after many years at the institution.

"Cap," as he was called by inmates, received a gift of \$128, a voluntary contribution of inmates. He told them when he left the prison: "All I want is to see you fellas do your time and get away from here."

"Your Cattle Need Help"
... and you can depend on "4x4" Beef Supplements to help your cattle...

Wilbur

By Staff Correspondent

Fifty friends and neighbors were entertained in the home of Mrs. Marie Hansen in honor of her birthday Saturday evening.

Mr. and Mrs. Walter Peterson were Friday evening guests in the Clarence Granquist home. Mr. and Mrs. Howard Gaunt visited in their home Sunday evening.

Friday evening visitors in the Luther Milliken home were Mr. and Mrs. Ed Mann and children and Mr. and Mrs. Wallace Anderson and children.

Guests in the Ervin Anthony home Friday evening were Mr. and Mrs. Ralph Watson, Diane Anthony was celebrating her sixth birthday.

Mr. and Mrs. August Kruse called in the Harry Miller home last Sunday.

High-powered automobiles are the best evangelists for good highways known to man.

HERE AND THERE... With Your County Agent

By Harold Ingalls

Social Security
Many farmers in the 60 and over age group in Nebraska are wondering just how the new social security law will affect them.

Since each farmer may have something different about his farming program that influences how the law applies to him, all farmers are urged to contact their local social security office if they haven't already done so.

Other older farmers feel that by getting into the program now they would be getting something they haven't earned.

Recent reports from the University of Minnesota tell about the important possibilities of "protective milk." Scientists there have discovered that cows vaccinated

with various disease antigens... produce milk which may make the consumer immune to the results of this disease.

The scientists working on the project caution that months of years of research work must be done to verify and test extensively this new principle of immunology.

Other older farmers feel that by getting into the program now they would be getting something they haven't earned.

Recent reports from the University of Minnesota tell about the important possibilities of "protective milk." Scientists there have discovered that cows vaccinated

Operates for an entire month on one 154 "A" battery... no "B" battery... greater economy, fewer battery changes... greater-than-ever durability!

ZENITH HEARING AID

price of only \$125
NEW! 3-TRANSISTOR, TUBELESS, "Royal-T" HEARING AID

Wakefield Rexall Drugs
Wakefield, Nebraska

For '56 choose FORD... America's Favorite Station Wagon!

With Thunderbird Y-8 power... Thunderbird styling... and exclusive new Lifeguard Design

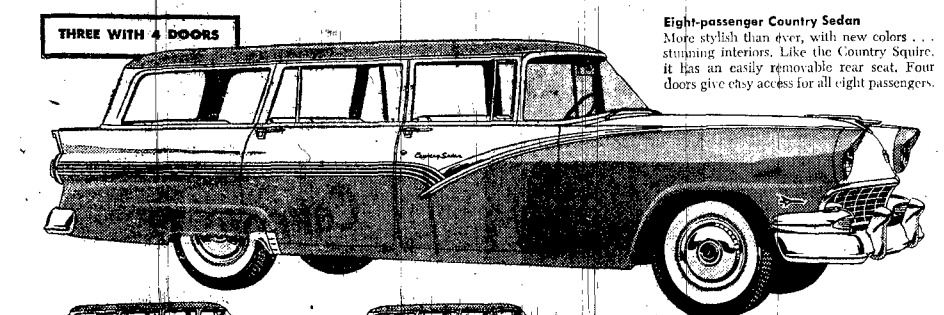

Eight-passenger Country Sedan. Most stylish than ever, with new colors... stunning interiors. Like the Country Squire, it has an easily removable rear seat. Four doors give easy access for all eight passengers.

There's more than meets the eye as to why Ford Station Wagons sell more than the two runners-up combined! Their Thunderbird beauty is apparent in all six models.

Country Squire. A queen among station wagons. Mahogany-finished steel panels give woodlike beauty to this luxurious, 8-passenger dreamboat.

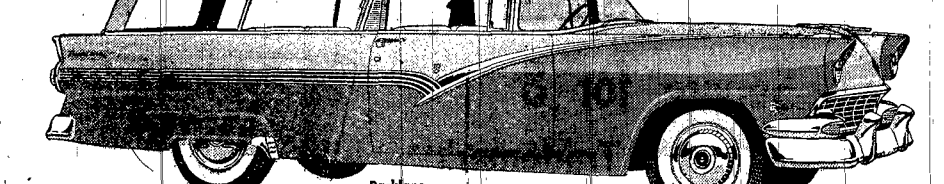

Parklane. Brand-new and carpeted throughout, this 2-door, 6-passenger handy has limousine comfort and does a mind-boggling job of its sleaves.

Ranch Wagon. This favorite has two wide doors, really seats 8 people. As in other models, lift gate and tail gate can be operated easily with one hand.

Custom Ranch Wagon. A 6-passenger beauty that converts in a split fifty from luxury liner to a super-spacious cargo carrier. Easy-to-clean interior can take it.

FORD STATION WAGONS
SEYLER MOTORS WAYNE TELEPHONE 303

Business and Professional DIRECTORY

CHIROPRACTORS	WAYNE CITY OFFICIALS	DENTISTS
Drs. Lewis & Lewis CHIROPRACTORS (Est. 1914) Neurological Service 112 East 4th St. Wayne, Nebr. Phone 49	Mayor—Glenn Houdersheldt 231 City Treasurer—Leslie W. Ellis 23-J City Clerk—Walter S. Bressler 298-J Councilmen— B. McClure 195 William Piel 481 T. J. Hughes 481-J Bernard Meyer 629-J Wm. A. Koeber 301 Ed Bane 780 POLICE—Call Operator S. Thompson, Dick Hansen, Walter Phipps, Wm. Eynon FIRE Call 340	R. E. Gormley. Dentist X-Ray Diagnosis 204 1/2 Main Phone 424-W
ELECTRICIANS	WAYNE COUNTY OFFICIALS	SEWING MACHINES
Tiedtke Electric Wiring Contractors Farm, Home and Commercial Tel. 227-W Wayne, Nebr.	Assessor, Henry Arp 198 Clerk, Ed Bane 38 Judge, David J. Hamer 258 Sheriff, Hans Tietgen 233 Supt., Gladys Porter 114 Treasurer, Leona Bahde 232 Clerk of District Court— John T. Bressler, Jr. 347 Agricultural Agent— Harold Ingalls 564 Assistance Director— Mrs. Helen Wischnoff 497 Attorney— Charles McDermott 317-W Commissioners— Dist. 1 Emil Meyer Dist. 2 George Stolz Dist. 3 Ed Glassmeyer	Tiedtke Plumbing Heating & Appliances American Standard General Electric Pfaff and Domestic Phone 227-W Wayne Nebraska
NURSING HOMES	PHYSICIANS	VETERINARIANS
Dahl Nursing Home Home for the aged and convalescent Clifford Dahl, owner and operator. Phone 18 918 Main St. Wayne, Nebr.	Benthack Clinic and Hospital 306 Pearl Street Wayne, Nebr. Clinic 106 Hospital 234	Drs. Harvey & Jensen VETERINARIANS 110 West First Street Wayne, Nebr.
REAL ESTATE	SERVICES	
Cavanaugh INSURANCE - REAL ESTATE Phone 84	Listing your profession in this directory assists others when needing your special services.	
OPTOMETRISTS		
W. A. Koeber, O.D. OPTOMETRIST 111 West 2nd Wayne, Nebr. Phone 305-J		

Thanksgiving... at Your House



Mr. and Mrs. Arlen Fitch and family are spending the day in the Fitch home, Pleasanton.

Mr. and Mrs. Ken Nuernberger are dining in the Carl Nuernberger home.

Mrs. Ed Ellis, York, is visiting Mr. and Mrs. Fred Ellis.

Mr. and Mrs. Kenneth de Freese are spending the day with his mother and aunt, Mrs. Mary de Freese and Mrs. Anna Kriebel, Fremont.

Mr. and Mrs. R. H. Banister and Mr. and Mrs. Richard Banister are dining in the C. W. Burns home, Sioux City.

Bob Batke is visiting his parents, Mr. and Mrs. T. C. Batke. Guests in the O. L. Black home are Mr. and Mrs. Donald Belter and Vicky Omaha, Mr. and Mrs. Fernie Freshman and sons, and Mr. and Mrs. Orville Black and Frank Black, Ogallala.

Mrs. J. D. Boyce is entertaining Mr. and Mrs. Walter Boyce and children, Ogallala, Mr. and Mrs. Clarence Bidsensiek and family, Cedar Falls, Ia., and Mr. and Mrs. Harold Bidsensiek and family, Phillipsburg, Mo.

Mrs. Waifred Carlson is visiting in the Gilbert Dangberg home, Winslow.

Mr. and Mrs. Roy Christensen are spending the day in the Ervin Katterman home, Pierce.

Mrs. Ed Lindsay and Florence are guests in the Frank Lindsay home.

Mr. and Mrs. Duane Peterson are visiting in the Mr. Millie Peterson and Rudolph Jigg homes, Hartington.

Guests in the Herban Beckman home are Mr. and Mrs. Charles Beckman and Linda, Mr. and Mrs. Emil Otto and Mr. and Mrs. John Rhoades.

Mr. and Mrs. Aldon Sederberg, Beatrice, are spending the day and weekend in the Elmer Harrison home.

Mr. and Mrs. Gerald Hasebrook are visiting in the Gerald Hale home.

Mr. and Mrs. David Hamer are dining with Mr. and Mrs. Paul Elliott, Omaha.

Guests in the M. I. Swihart home, Carroll, are Mr. and Mrs. Evan Hamer, Mr. and Mrs. Charles Scribner, South Sioux City, Mr. and Mrs. Dave Thomas and Billy, Valentine, and their son, Keith, Thomas, Omaha, Mr. and Mrs. Glen Jenkins and family, Norfolk, will call in the evening.

Mr. and Mrs. S. J. Hale are visiting in the Dale Hale home.

Mr. and Mrs. M. A. Gray are spending the day with Mrs. Gray's parents, Mr. and Mrs. Irving Tenges, Norfolk.

Mr. and Mrs. Wilmer Griess are visiting Mr. and Mrs. Herman Griess, Sutton.

Gertude Pfeiffer, Arlington, is entertaining Mr. and Mrs. Ralph Crockett.

Rev. Conner is visiting his father, William Conner, McPetersburg, Kan. William Conner is seriously ill.

Mr. and Mrs. Eph Beckenhauer, Dr. and Mrs. T. T. Jones, Mr. and Mrs. Don Beckenhauer and family are guests in the Ralph Beckenhauer home.

Mr. and Mrs. Alvin Temme are in the Charles Temme home.

Mr. and Mrs. Ward Gilliland are guests in the Al Kern home.

Guests in the Maunso Ulrich home are Mr. and Mrs. Charles Wittler.

Guests in the Ed Kenny home, Carroll, are Mr. and Mrs. Ralph Watson, Mr. and Mrs. Dean Reimers and Bonnie, Mr. and Mrs. Bill Kenny and Doug, Winslow and Mr. and Mrs. Helen Kenny and family, Carroll.

Mr. and Mrs. Kenneth Dunklau and family, Mr. and Mrs. Howard Mau and family and Mr. and Mrs. Will Lutt are spending the day in the Virgil Moseman home, Emerson.

Mrs. Charles Baird, Mr. and Mrs. Neyron Woodward and Mr. and Mrs. Thayne Woodward are at the Earl Baird's Omaha.

Guests in the Jens Christensen home are Mr. and Mrs. Don Christensen and Bobby, Ogallala, Mr. and Mrs. Bud Saphal, Columbus, Mr. and Mrs. Libyd Manske and family, Creighton, Mr. and Mrs. Leonard Denkinger, and Mrs. C. H. Sandahl.

Mr. and Mrs. Wayne Christensen are visiting in the Chester Cates home, Cheyenne.

Mr. and Mrs. L. O. Her, Sioux Falls, and Mr. and Mrs. Robert Norton and family, Filley, are dining in the Arthur Conner home.

Mr. and Mrs. Russell Pryor are guests in the Gilbert Dangberg home.

Guests in the John Gruenke home, Fremont, are Mr. and Mrs. Herbert Gerlehan.

Mr. and Mrs. Ted Hoeman are guests in the home of Mr. and Mrs. Kenneth Baker, Wakefield.

Guests in the Clifford Pinkleman home are Mr. and Mrs. Jim Kelly and family, Wichita, and Mrs. Ivan Oocook and Mr. and Mrs. Joe Pinkleman.

Mr. and Mrs. Albert Nelson are guests in the home of Mr. and Mrs. David Christman, Ute, Ia.

Mr. and Mrs. Mary Loring, the Kurlenmeyers and the Silvers, Relatives of Mrs. Willis Nelson are guests in the Willis Nelson home.

Mr. and Mrs. John Rhoades are guests in the Herman Brockmann home, Winslow.

Mr. and Mrs. Elmer Willers are in Merville, Ia., in the Robert Anderson home.

Mr. and Mrs. Albert Bichel are spending the day in the Julius Menke home, Carroll.

Rev. Conner is visiting in the Emil Utecht home.

Guests in the Harry Lentz home, Hartington, are Mr. and Mrs. Peter Haberer.

Mr. and Mrs. Alden Dunklau are spending the day in the Fredrick Janke home.

Guests in the Cyril Hansen home, Hoskins, are Mr. and Mrs. Will Hansen.

Mr. and Mrs. Harold Ekberg are in the Harvey Grossed home today.

Guests in the Ed Gathje home are Mr. and Mrs. Russell Beckman, Mr. and Mrs. John Gathje, Mr. and Mrs. Glenn Gathje and family, Mrs. Christina Gathje and Herman Gathje.

Guests in the Virgil Kardell home are Mr. and Mrs. Oscar Kardell and Shirleene, Mr. and Mrs. Kenneth Kardell and Danny and Mr. and Mrs. Clifford Carlson and family.

Dinner guests in the George Brammer home are Mr. and Mrs. LeRoy Elison and family, Wahoo, Verdel Ruwe, Lincoln, Mr. and Mrs. Lawrence Ruwe and Harlan, Mr. and Mrs. Ernest Brammer and daughters, Mr. and Mrs. Henry Wieting and daughter, Mr. and Mrs. Don Wright and family and Mr. and Mrs. Don Peterson and son, Windon.

Guests in the Paul Fischer home are Mr. and Mrs. John Beckenhauer and sons, Mr. and Mrs. Emil Rodgers, Allen, and Mr. and Mrs. Harry Kinder.

Mr. and Mrs. Wilbur Giese and sons are guests in the Levi Giese home.

Anna Pohlman, Stanton is a guest in the Arthur Bronzynski home.

Mr. and Mrs. Carl Bronzynski and Mr. and Mrs. Albert Gamble are dinner guests in the Ray Gamble home.

Mr. and Mrs. Harold Gildersleve are entertaining Mr. and Mrs. Ervin Brandt, Norfolk, and Mr. and Mrs. Harry Wert at dinner.

Mr. and Mrs. Everton Fisher, Concord, are visiting in the Maurice Fisher home.

Mrs. George Patterson is spending the day with Mr. and Mrs. Harold Sorenson.

Mr. and Mrs. J. S. Schortinghuis, Atlantic, Ia., Mr. and Mrs. Clarence Marra and family, Rock Rapids, Ia., and Mr. and Mrs. David Schortinghuis, Wayne, are guests in the Erwin Vahlkamp home.

Mr. and Mrs. Chris Baier are spending the day in the Julius Menke home, Carroll.

Mr. and Mrs. Marvin Pospishil are in the home of Mrs. Pospishil's parents, Mr. and Mrs. Adolph Clausen.

Mr. and Mrs. W. C. West are in the Marvin Gunderson home, Magnat.

Guests in the Florenz Niemann home are Mr. and Mrs. Ray Reeg and Mr. and Mrs. Fred Reeg.

Mr. and Mrs. Henry Wacker, Jr. and Mr. and Mrs. Artie Fisher, Winslow, are guests in the Clyde Bucher home, Sioux City.

Mr. and Mrs. Raymond Florine are in the Arthur Florine home, Wakefield.

Mr. and Mrs. Ed Watkins and Barbara are spending the day in the John Surber home.

Mr. and Mrs. Ted Fuoss and family are in the home of Mr. and Mrs. Dale Jones, Osmond.

Guests in the Reuber Meyer home are Mr. and Mrs. Fred Meyer, Mr. and Mrs. Harvey Echtenkamp and Lavone and Mr. and Mrs. Gilmore Sahs.

Mr. and Mrs. Rudolph Roebber are in the Lester Heimstra home, Marcus, Ia.

Mr. and Mrs. Ernest Echtenkamp are visitors in the Delmar Holdorf home, Laurel.

Guests in the C. H. Frevert home are Mr. and Mrs. Edmund Heald.

Mr. and Mrs. Clifford Hale are in the Gerald Hale home.

Mr. and Mrs. Herman Steube are guests in the Albert Steube home, Wakefield.

Mr. and Mrs. Wayne Stammer and family, Omaha, are visiting Mr. and Mrs. C. A. Preston.

Mr. and Mrs. C. C. Powers are spending the day with their son, Dale Powers and family, Osmond.

Mr. and Mrs. Adolph Clausen are entertaining Mr. and Mrs. Elhardt Pospishil.

Mrs. Vallie Sprague and Mr. and Mrs. Anton Pederson are dining in the W. L. Phipps home.

Guests in the Paul Peterson home are Mr. and Mrs. Ismael Hughes and Janie, Mr. and Mrs. Larry Bowers, Omaha, Clyde McIntire, Glenwood, Ia., and Mr. and Mrs. Hays Hampton, Fremont.

Mr. and Mrs. Franklin Philleo are visiting Mr. and Mrs. Harry Armstrong, Sioux City.

Mr. and Mrs. T. I. Friest and Wendell Plattsmuth will spend the evening in the Franklin Philleo home.

NORTHEAST Wayne

• By Staff Correspondent

Mr. and Mrs. Clifford Carlson were Tuesday evening guests in the Edward Linn home, Laurel. They were Friday callers in the Virgil Kardell home.

Sherri Nelson spent Thursday afternoon in the Robert B. Meyer home.

Mr. and Mrs. Glenn Granquist were Sunday dinner guests in the Raymond Florine home.

Barbara Stringer was a Friday overnight guest in the Mark Stringer home.

Mrs. Virgil Kardell visited Mrs. Richard Carlson in Bentback hospital Thursday evening.

SOUTHEAST Wayne

• By Staff Correspondent

Mr. and Mrs. Paul Fischer accompanied Mr. and Mrs. Harvey Henningson and Rodney to Lincoln for the Farm Bureau convention Sunday and Monday.

Loouen Eckert and Roland Harsch spent last Wednesday in the Floyd Echtenkamp home.

Callers during the past week in the Virgil Kardell home to visit Janet were Mr. and Mrs. Don Miles and Jerry, Mr. and Mrs. Kenneth Kardell and Danny, Joan and Diane Salmon, Roger Hansen, Robert Frahm, Mr. and Mrs. Edward Linn and Jeanine, Mrs. Harold Gunnerson and Verlie, Mr. and Mrs. Oscar Kardell and Shirleene, Mr. and Mrs. Clifford Carlson and family and Mr. and Mrs. Reinhardt Michael and Dale.

Mr. and Mrs. Roy Pierson were last Tuesday evening supper guests in the Walter Bressler home.

The Wayne (Nebr.) Herald, Thursday, November 24, 1955

David Christman, Ute, Ia., Mr. and Mrs. Ruben Buss and Peggy, Mr. and Mrs. Arthur Behmer and Yvonne, Hoskins, Mr. and Mrs. Glenn Frevert, Winslow, Mr. and Mrs. Merlin Biermann, and Russell Bichel. Later in the evening Mr. and Mrs. Robert Hansen and Dale and Mr. and Mrs. Merle Baier joined them. Prizes were won by Mr. and Mrs. Merlin Biermann, Mrs. Buss, Russell Bichel and Robert Hansen.

Last weekend guests in the Roland and Emil Weyhrich homes, O'Neill, were Mr. and Mrs. William Schnoor.

A party honoring Albert Nelson, Mr. and Mrs. LeRoy Stevers and family and Mr. and Mrs. Ed Kuehlmeier were last Sunday afternoon guests in the Albert Damme home.

A party honoring Albert Nelson, Mr. and Mrs. Gerald Grone was given last Tuesday evening supper guests in the Walter Bressler home.

NEED SOMETHING?
SEE WANTEDS?

TOYLAND IS OPEN

AT Firestone

We Will Be Open Nights on Dates Shown in Black

KIDS - GET FREE TRAIN RIDE TICKETS HERE

1955	DEC	24	25	26	27	28	29	30	31
Su	Mo	Tu	We	Th	Fr	Sa			
		1	2	3	4	5	6	7	8
9	10	11	12	13	14	15	16	17	18
19	20	21	22	23	24	25	26	27	28
29	30	31							

Includes Three Jet Planes

4.95

36-INCH AIRCRAFT CARRIER KIT

An elevator lifts the planes to the deck. Has a plane that fires six shells automatically, a bomber and a rocket firing plane.

The Best in Realistic Action!

ALL-STAR ELECTRIC FOOTBALL GAME

6.95

Players run through the line, pass, block, tackle, and kick. Includes 22 football players, footballs and all necessary equipment.

DOUBLE HOLSTER SET genuine leather 1.98

Two realistic pistols and colorful holsters and belt.

MOM and DAD use the Firestone LAYAWAY PLAN a small deposit holds any item!

Two For The Money 3.98

Just like on T. V. Two giant quiz books, timer and money calculator.

AIR FLEET SET 4.98

5 big planes. All plastic, easy to assemble. Authentically scaled.

22" BABY DOLL with special rooted hair 7.98

• Saran rooted hair can be shampooed and curled. Cuddly doll is very lifelike. Clothes included.

GIANT TEDDY BEAR 27" high 5.98

• Made of rich rayon plush. Giant bear has cute vinyl face.

PARTY TEA SET 28 big pieces 3.98

All plastic service for four. Red and white.

GOLDEN TRUMPET 3.98

Easy to play. Instruction book and carrying case.

PIANO ACCORDION 7.98

Plays like real thing. Music book and case.

LIIONEL TRAINS and ACCESSORIES

Cars, Switches, Engines, Track, Loaders, Transformers, etc.

COMPLETE SETS FROM 15.99 UP

Featuring... MAGNE-TRACTION

Permanent magnetic power in the wheels of these Lionel trains give tremendous pulling power... even up steep grades. More realism, more thrills, more fun!

BUY ON EASY BUDGET PAYMENT PLAN

REPAIR-IT TRUCK... with TOOLS 5.98

• Has bumper jack, wrench, hammer and screwdriver for road repairs.

All 7 wheels removable and interchangeable. Full 26 1/2" overall length. Well made.

DON'T DELAY... SEE OUR TOYLAND BEFORE SANTA CLAUS RUNS OUT OF YOUR FAVORITE TOY!

Both Protect You...

Both Are Modern!

merce Commission. Congress has enacted more than 150 amendments to the Interstate Commerce Act since it was passed in 1887, completely overhauling it twice.

In principle, present ICC regulations governing the various transportation systems are pertinent, constructive, and modern in concept. Under these principles, we have developed the greatest competitive transportation system in the world!

Your rights and privileges as an American citizen are protected by the Constitution, a unique and magnificent document whose principles are as sound today as when written, over 150 years ago. Through the years, amendments have been added to keep the Constitution up-to-date.

The same is true of the regulatory powers of the Interstate Com-

AN ACT TO REGULATE COMMERCE

We'll People

NEBRASKA MOTOR CARRIERS' ASSOCIATION, INC.

1320 J Street • Lincoln, Nebraska

Affiliated With The American Trucking Associations, Inc. • Washington 6, D. C.

What's Good Enough For The Country Should Be Good Enough For The Railroads!

Ellis Firestone Store

222 Main A. R. Ellis, Owner Phone 126

CONCORD Merry Homemakers Elect Mrs. R. Erwin President

Mrs. Ruth Erwin was elected president of Merry Homemakers club last Wednesday afternoon at the home of Mrs. Delmar Carlson. Other officers named were Mrs. Mae Pearson, vice president, and Mrs. Betty Anderson, secretary-treasurer. Next meeting will be Christmas luncheon.

Guests in the Eric Nelson home Thursday evening to help him celebrate his birthday were Mr. and Mrs. Dean Backstrom, Mr. and Mrs. Jack Erwin and family, Mr. and Mrs. Pat Erwin and family, Mr. and Mrs. Clifford Stalling and family, Mr. and Mrs. LaVerne Clarkson and Debbie, Doris and Phyllis Johnson, Fritz Kraemer and Don Hagberg.

Saturday evening dinner guests in the Delmar Carlson home in honor of Veril Dean were Mr. and Mrs. Herman Kraemer and Fritz, Mr. and Mrs. Gene Ketsamer and son, Mr. and Mrs. Billy Kraemer and family, Coleridge and Phyllis Johnson.

Mr. and Mrs. Dean Backstrom, Wayne, visited in the Pat Erwin home Wednesday evening.

Naomi Nelson called on Verlie Gunnarson Thursday evening.

Sunday dinner and supper guests in the Herman Kraemer home were Mr. and Mrs. Virgil Carlson, Mr. and Mrs. Delmar Carlson and Joleen, Mr. and Mrs. Billy Kraemer and family, Mr. and Mrs. Gene Kraemer and son and Phyllis Johnson.

Churches...

St. Paul's Lutheran Church
(R. Herrmann, pastor)
Sunday, Nov. 27: Sunday school, 10 a.m.; divine services, 10:45.

Evangelical Free Church
Sunday, Nov. 27: Sunday school, 10 a.m.; worship, 11; evening service, 7:45 p.m.
Wednesday, Nov. 30: Midweek service, 8 p.m.

Concordia Lutheran Church
(Ernest C. Nelson, pastor)
Thursday, Nov. 24: Thanksgiving supper, 5:30 p.m.; thanksgiving, 8.

Sunday, Nov. 27: Sunday school, 9:45 a.m.; divine worship, 11; WMS Prayer Day service, 8 p.m.

Mr. and Mrs. Jack Erwin attended the Nebraska-Oklahoma football game at Lincoln Saturday. They spent Saturday night and Sunday in the Arnold Peterson home, Omaha.

Friday evening dinner guests in the Virgil Pearson home were Mr. and Mrs. Anton Granquist and Mr. and Mrs. Howard Gaunt and family. Mr. and Mrs. Melvin Magnuson and boys and Mr. and Mrs. Harvey Taylor and family called in the evening.

Mr. and Mrs. Vernal Peterson and family and Naomi Nelson were Sunday dinner guests in the Arvid Peterson home.

Wednesday evening guests in the Paul Bose home for Verlie's ninth birthday were Mr. and Mrs. Anton Granquist, Mr. and Mrs. Howard Gaunt and family, Mr. and Mrs. Virgil Pearson and family and Mr. and Mrs. Bill Wolters, Laurel.

Mr. and Mrs. Henry Johnson and boys and Mr. and Mrs. Vernal Peterson and girls were Friday evening guests in the Arvid Peterson home.

Guests in the Glenn Graffes home Tuesday afternoon were Mr. and Mrs. Melvin Miller, Randolph, and Mrs. Blair Van Slyke, Boise, Ida.

Veril Dean Carlson left Monday morning for the Navy. He will be stationed at San Diego, Calif. for boot training.

Mrs. C. E. Martindale and family and East Hughes visited Elmer Willmarth in the Wakefield hospital Sunday afternoon.

Sunday dinner guests in the Harold Gunnarson home were Mr. and Mrs. Clarence Dahquist and Harris, Mr. and Mrs. Marland Dahquist and Alex Brown.

Mr. and Mrs. Clifford Carlson and family called in the Edward Linn home Tuesday evening.

Sunday dinner guests in the Pat Erwin home were Mr. and Mrs.

CONCORD

Mrs. Glenn Paul

Eric Nelson and family, Mr. and Mrs. Clifford Stalling and Scotty, Mr. and Mrs. LaVerne Clarkson and Debbie and Doris Johnson.

Mr. and Mrs. Arvid Peterson and Mr. and Mrs. Vernal Peterson and girls were guests Thursday evening of Mrs. C. J. Magnuson.

Sunday dinner guests in the Verdel Erwin home for Tommy's fifth birthday were Mr. and Mrs. Clarence Pearson and Jimmy, Mr. and Mrs. Clarence Rastede and family, Mr. and Mrs. Marvin Johnson and Mr. and Mrs. Dean Pearson, Orchard.

Mr. and Mrs. Edward Linn and Jeanette called in the Virgil Kardell home Thursday evening.

Mr. and Mrs. Harold Burns and Mr. and Mrs. Glenn Graffes spent Wednesday in Omaha.

Sunday dinner guests of Mrs. Geneva Sullivan were Mel and Mrs. Stanley Swanson and boys, Mrs. Florence Clark and Bill Clark.

Mrs. William Haskell, Mrs. D. A. Paul and Mrs. Glenn Paul and family spent Friday in Sioux City.

Otto Miller's birthday was observed last Sunday evening when guests were Mr. and Mrs. Emil Bargholz, Mr. and Mrs. Chris Bargholz, Mr. and Mrs. Walter Reeg and family, Mr. and Mrs. August Longe, Mr. and Mrs. Arthur Longe and family and Dorel Franzen.

Cards were played and cooperative lunch was served. Mrs. Harry Echtenkamp and Darlene, Belden, Mrs. Fred Thun and Betty Jean, Salina, Kan. and Margaret Dougherty were afternoon and lunch guests.

Mr. and Mrs. Barney Conley and daughters, Omaha, visited Mr. and Mrs. Otto Miller from last Saturday to Monday.

Mr. and Mrs. Otto Miller were guests at the Carl Doescher home, Wakefield, Sunday.

Mr. and Mrs. Wymore Wallin, Mrs. Roy E. Johnson and Albin Peterson attended the funeral of their aunt, Mrs. Charles Erickson.

Omaha, Friday. Mrs. Erickson was the former Jeanette Reuter. She was living with her daughter in Salt Lake City, Utah, at the time of her death.

Mrs. Ernest Nelson, Mrs. Pat Erwin, Mrs. Verdel Erwin, Mrs. Cecil Clark and Doris Johnson were guests of Mrs. Herman Rieth Friday afternoon.

Clayton Erwin spent the weekend in the Eric Nelson home.

Mrs. Jewell Finn and boys, Missouri Valley, Ia., were weekend guests in the Virgil Pearson home.

Mr. and Mrs. E. E. Fisher and Mr. and Mrs. Bud Fisher and family spent Sunday in Cozad visiting in the Ronald Fisher home.

Mr. and Mrs. Melvin Magnuson and boys were Sunday dinner guests of Mrs. Otelia Magnuson. In the afternoon all visited Arden Olson in a Sioux City hospital.

Mr. and Mrs. George Schroeder and Jeanette visited in the Bill Erwin home, South Sioux City, and in the Gary Erwin home, Sioux City, Wednesday afternoon.

Mr. and Mrs. Olaf Nelson, Mr. and Mrs. George Volters and family and Mr. and Mrs. Art Boeschen and family were Sunday dinner guests in the Robert Kennedy home, Winslow.

Mr. and Mrs. LeRoy Olson, Mrs. Esther Hogie and James Gleason spent Saturday in Sioux City.

Mr. and Mrs. Arvid Peterson spent Sunday evening in the Vernal Peterson home.

4-H Club News

Handy Helpers

Handy Helpers club was organized at St. Mary's school Thursday. Officers were elected. President is Esther Haberer; vice-president, Nicole McLean; secretary, Leslie Conyers; treasurer, Shirley Meyer; and news reporter, Jean Conyers.

REPORT YOUR NEWS!

PHONE
130

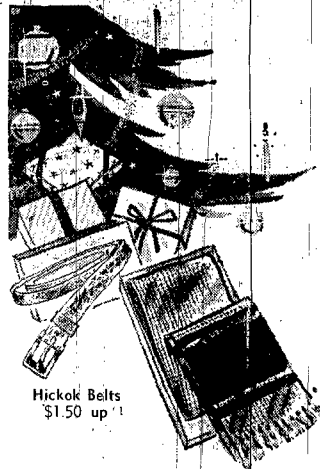

Hickok Belts
\$1.50 up!

Botany Mufflers
\$1.00 up



Arrow, Marlboro
Sport Shirts
\$3.95 up



Evans Slippers
\$3.95



Deerskin Gloves
\$3.95 up



Interoven Socks
65c up



Jersild Sweaters
\$7.95 up

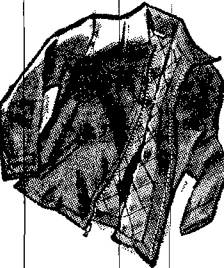

Weathercrest Jackets
\$12.95 up

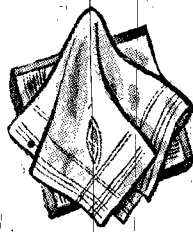

Arrow Handkerchiefs
35c up

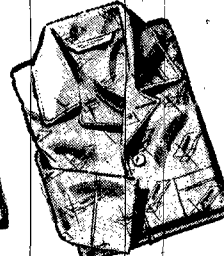

Weldon Fajamas
\$3.95 up



Suburban Coats
\$19.95 up

take these shortcuts
to a man's heart
at
Christmas

**Give a Man a Gift He Can Wear...
Choose Here the Gift He'll Like Best!**

We make it our business to know what men like to wear. So why not make it your business to gift-shop here for all the men in your Christmas? Whether you spend much or little, you can be sure that every gift you choose will score a solid hit, because it's styled to a MAN'S taste. Come see, select and buy... with confidence from such names as Kingsridge, Season Skipper and Alpagora.

Season Skipper Slacks

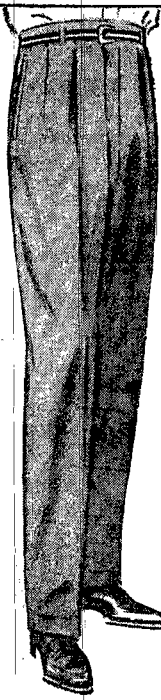

1295
to
1995

Good Looking everywhere you go

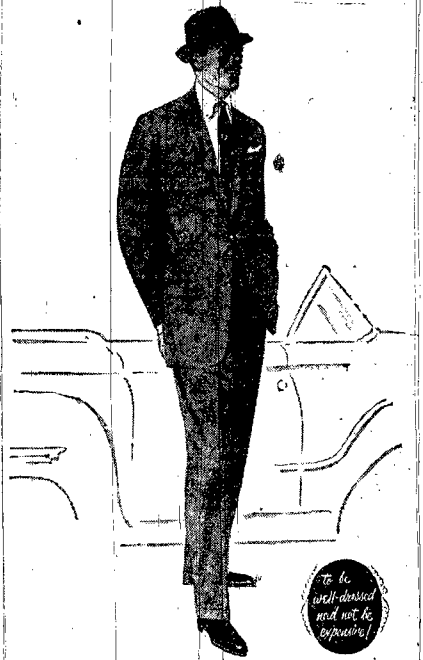

**CLOTHCRAFT
FLANNELS**

Give Him a Florsheim Gift Certificate



FLORSHEIM
America's Most Distinguished Shoel

Larson's Clo. Store

Good Clothes for Men and Boys

Why Don't You Open a
Larson's Easy Payment
Plan Account Today?

Enjoy your new clothing while
making monthly payments.
Small down payment. Ask for
details today!

this
Overcoat
rises to your
most important
occasions...



\$39.50
up

SEASON SKIPPER — ALPAGORA
A preferred investment in
good appearance, comfort
and long, prideful wear!

Here's a coat that takes the snap out of the air and puts it in to your appearance! Warm as toast, yet rests light-as-a-feather on your shoulders. Balzacian collar buttons high for extra protection against the weather. Deep slash pockets. See it!

**LARSON'S
CLOTHING STORE**

"GOOD CLOTHES FOR MEN AND BOYS"

HEADQUARTERS

FOR THE FAMOUS
AUDIOTONE HEARING AIDS
Fully guaranteed. Batteries,
supplies for all makes... Let us
take care of all your hearing needs
... See us for Free Demonstration.

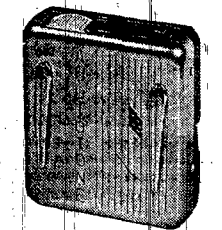

Prices
Start at **9950**
BATTERIES for All Makes

2 Registered
Pharmacists to Serve You
**Felber
Pharmacy**
Reliable Prescription
Service Since 1906

LEGAL NOTICES

Every government official or board that handles public money should publish at regular intervals an accounting of its showing where and how each dollar is spent. We hold this to be a fundamental principle of democratic government.

LEGAL PUBLICATION

NOTICE OF THE MEETING OF THE CITY COUNCIL AS A BOARD OF EQUALIZATION
 Notice is hereby given to all persons interested that at 7 o'clock P. M. on the 14th day of December, 1955, at the City Clerk's office in the City Auditorium, the Council of the City of Wayne, Nebraska, will meet in special session as a Board of Equalization for the purpose of reviewing the special assessments for the year 1955. The Board of Equalization will also consider the levying of such assessments for the year 1956. A statement of the costs of the improvements and a plat of the property in the district, and a schedule of the amount proposed to be assessed against each separate piece of property in the District, is on file in the office of the City Clerk.

SEWER DISTRICT NUMBER 16
 The final results included in said district are as follows:
 Lot 1 & 2
 Lot 3 & 4
 Lot 5 & 6
 Lot 7 & 8
 Lot 9 & 10
 Lot 11 & 12
 Lot 13 & 14
 Lot 15 & 16
 Lot 17 & 18
 Lot 19 & 20
 Lot 21 & 22
 Lot 23 & 24
 Lot 25 & 26
 Lot 27 & 28
 Lot 29 & 30
 Lot 31 & 32
 Lot 33 & 34
 Lot 35 & 36
 Lot 37 & 38
 Lot 39 & 40
 Lot 41 & 42
 Lot 43 & 44
 Lot 45 & 46
 Lot 47 & 48
 Lot 49 & 50
 Lot 51 & 52
 Lot 53 & 54
 Lot 55 & 56
 Lot 57 & 58
 Lot 59 & 60
 Lot 61 & 62
 Lot 63 & 64
 Lot 65 & 66
 Lot 67 & 68
 Lot 69 & 70
 Lot 71 & 72
 Lot 73 & 74
 Lot 75 & 76
 Lot 77 & 78
 Lot 79 & 80
 Lot 81 & 82
 Lot 83 & 84
 Lot 85 & 86
 Lot 87 & 88
 Lot 89 & 90
 Lot 91 & 92
 Lot 93 & 94
 Lot 95 & 96
 Lot 97 & 98
 Lot 99 & 100

NOTICE OF HEARING OF PETITION FOR FINAL SETTLEMENT
 County Court of Wayne County, Nebraska, Estate of Neil Nelson, Deceased.
 Notice is hereby given that a petition has been filed for the final settlement of the estate of Neil Nelson, deceased, and that a hearing will be held on the said petition at 10:30 o'clock A. M. on the 14th day of December, 1955, at the County Court House, in the City of Wayne, Nebraska.

LEGAL PUBLICATION
 County Court of Wayne County, Nebraska, Estate of Neil Nelson, Deceased.
 Notice is hereby given that a petition has been filed for the final settlement of the estate of Neil Nelson, deceased, and that a hearing will be held on the said petition at 10:30 o'clock A. M. on the 14th day of December, 1955, at the County Court House, in the City of Wayne, Nebraska.

NOTICE OF HEARING OF PETITION FOR FINAL SETTLEMENT
 County Court of Wayne County, Nebraska, Estate of Neil Nelson, Deceased.
 Notice is hereby given that a petition has been filed for the final settlement of the estate of Neil Nelson, deceased, and that a hearing will be held on the said petition at 10:30 o'clock A. M. on the 14th day of December, 1955, at the County Court House, in the City of Wayne, Nebraska.

NOTICE OF HEARING OF PETITION FOR FINAL SETTLEMENT
 County Court of Wayne County, Nebraska, Estate of Neil Nelson, Deceased.
 Notice is hereby given that a petition has been filed for the final settlement of the estate of Neil Nelson, deceased, and that a hearing will be held on the said petition at 10:30 o'clock A. M. on the 14th day of December, 1955, at the County Court House, in the City of Wayne, Nebraska.

NOTICE OF HEARING OF PETITION FOR FINAL SETTLEMENT
 County Court of Wayne County, Nebraska, Estate of Neil Nelson, Deceased.
 Notice is hereby given that a petition has been filed for the final settlement of the estate of Neil Nelson, deceased, and that a hearing will be held on the said petition at 10:30 o'clock A. M. on the 14th day of December, 1955, at the County Court House, in the City of Wayne, Nebraska.

NOTICE OF HEARING OF PETITION FOR FINAL SETTLEMENT
 County Court of Wayne County, Nebraska, Estate of Neil Nelson, Deceased.
 Notice is hereby given that a petition has been filed for the final settlement of the estate of Neil Nelson, deceased, and that a hearing will be held on the said petition at 10:30 o'clock A. M. on the 14th day of December, 1955, at the County Court House, in the City of Wayne, Nebraska.

NOTICE OF HEARING OF PETITION FOR FINAL SETTLEMENT
 County Court of Wayne County, Nebraska, Estate of Neil Nelson, Deceased.
 Notice is hereby given that a petition has been filed for the final settlement of the estate of Neil Nelson, deceased, and that a hearing will be held on the said petition at 10:30 o'clock A. M. on the 14th day of December, 1955, at the County Court House, in the City of Wayne, Nebraska.

NOTICE OF HEARING OF PETITION FOR FINAL SETTLEMENT
 County Court of Wayne County, Nebraska, Estate of Neil Nelson, Deceased.
 Notice is hereby given that a petition has been filed for the final settlement of the estate of Neil Nelson, deceased, and that a hearing will be held on the said petition at 10:30 o'clock A. M. on the 14th day of December, 1955, at the County Court House, in the City of Wayne, Nebraska.

NOTICE OF HEARING OF PETITION FOR FINAL SETTLEMENT
 County Court of Wayne County, Nebraska, Estate of Neil Nelson, Deceased.
 Notice is hereby given that a petition has been filed for the final settlement of the estate of Neil Nelson, deceased, and that a hearing will be held on the said petition at 10:30 o'clock A. M. on the 14th day of December, 1955, at the County Court House, in the City of Wayne, Nebraska.

Leslie
 By Mrs. George Buskirk
 Phone Area 7-2523
 Orval Ruckett, Montana, arrived Saturday for a visit with his son, Darrel and family.
 Mrs. George Buskirk was a Friday visitor in the Clark Buskirk home, Omaha. She accompanied them to Wakefield and all attended the fellowship dinner at the Christian church honoring Evangelist Cy Welch, Footsville, Wis.

Legion Auxiliary
 Plans for a Christmas party were completed at a meeting of Randolph Legion Auxiliary Tuesday night at the Legion hall. The party will begin with a covered dish Dec. 11 and will include members of both the Legion and Auxiliary. Each one is to bring a 50c exchange. Gifts for five boys and five girls were sent to the girl shop at Lincoln Veterans hospital. Mrs. Harold Rohde presided at the business meeting. Lunch was served by Mrs. Rohde and Mrs. Roy Gibson.

Pock New President
 John Pock has accepted the presidency of Randolph community club for the coming year. Vernon Viergutz was elected to the post at their annual election of officers several weeks ago but declined.

Parents Night
 Despite poor weather conditions, Parents Night at the Randolph Public school last Tuesday night was well attended. Seventy-four families were represented.

16 Games Scheduled By St. Frances Cagers
 Basketball practice for St. Frances High is now in full swing with 16 games scheduled for the season. First team prospects will be Charles Tunkin, Richard Wurdinger, Dick Marx, John Leasley, Clarence Wattier, Herman Nordhus, Gene Gubbs, LaVern Scott, Leon Schler, and Ricky Kelsch. Besides the first team material there are 17 others out for basketball.

2,000 Attend Annual Pancake Day at Randolph
 Approximately 2,000 enjoyed Randolph's Pancake Day, sponsored by the Community club, Saturday at the city auditorium. Free pancakes were served by the members of the club from 3-8 p.m. Prizes were donated by Randolph businessmen. There was a pancake eating contest. Participants for this contest

Legal Publication
 County Court of Wayne County, Nebraska, Estate of Neil Nelson, Deceased.
 Notice is hereby given that a petition has been filed for the final settlement of the estate of Neil Nelson, deceased, and that a hearing will be held on the said petition at 10:30 o'clock A. M. on the 14th day of December, 1955, at the County Court House, in the City of Wayne, Nebraska.

Legal Publication
 County Court of Wayne County, Nebraska, Estate of Neil Nelson, Deceased.
 Notice is hereby given that a petition has been filed for the final settlement of the estate of Neil Nelson, deceased, and that a hearing will be held on the said petition at 10:30 o'clock A. M. on the 14th day of December, 1955, at the County Court House, in the City of Wayne, Nebraska.

Legal Publication
 County Court of Wayne County, Nebraska, Estate of Neil Nelson, Deceased.
 Notice is hereby given that a petition has been filed for the final settlement of the estate of Neil Nelson, deceased, and that a hearing will be held on the said petition at 10:30 o'clock A. M. on the 14th day of December, 1955, at the County Court House, in the City of Wayne, Nebraska.

Legal Publication
 County Court of Wayne County, Nebraska, Estate of Neil Nelson, Deceased.
 Notice is hereby given that a petition has been filed for the final settlement of the estate of Neil Nelson, deceased, and that a hearing will be held on the said petition at 10:30 o'clock A. M. on the 14th day of December, 1955, at the County Court House, in the City of Wayne, Nebraska.

Legal Publication
 County Court of Wayne County, Nebraska, Estate of Neil Nelson, Deceased.
 Notice is hereby given that a petition has been filed for the final settlement of the estate of Neil Nelson, deceased, and that a hearing will be held on the said petition at 10:30 o'clock A. M. on the 14th day of December, 1955, at the County Court House, in the City of Wayne, Nebraska.

Legal Publication
 County Court of Wayne County, Nebraska, Estate of Neil Nelson, Deceased.
 Notice is hereby given that a petition has been filed for the final settlement of the estate of Neil Nelson, deceased, and that a hearing will be held on the said petition at 10:30 o'clock A. M. on the 14th day of December, 1955, at the County Court House, in the City of Wayne, Nebraska.

Legal Publication
 County Court of Wayne County, Nebraska, Estate of Neil Nelson, Deceased.
 Notice is hereby given that a petition has been filed for the final settlement of the estate of Neil Nelson, deceased, and that a hearing will be held on the said petition at 10:30 o'clock A. M. on the 14th day of December, 1955, at the County Court House, in the City of Wayne, Nebraska.

Legal Publication
 County Court of Wayne County, Nebraska, Estate of Neil Nelson, Deceased.
 Notice is hereby given that a petition has been filed for the final settlement of the estate of Neil Nelson, deceased, and that a hearing will be held on the said petition at 10:30 o'clock A. M. on the 14th day of December, 1955, at the County Court House, in the City of Wayne, Nebraska.

Legal Publication
 County Court of Wayne County, Nebraska, Estate of Neil Nelson, Deceased.
 Notice is hereby given that a petition has been filed for the final settlement of the estate of Neil Nelson, deceased, and that a hearing will be held on the said petition at 10:30 o'clock A. M. on the 14th day of December, 1955, at the County Court House, in the City of Wayne, Nebraska.

Legal Publication
 County Court of Wayne County, Nebraska, Estate of Neil Nelson, Deceased.
 Notice is hereby given that a petition has been filed for the final settlement of the estate of Neil Nelson, deceased, and that a hearing will be held on the said petition at 10:30 o'clock A. M. on the 14th day of December, 1955, at the County Court House, in the City of Wayne, Nebraska.

Leslie
 By Mrs. George Buskirk
 Phone Area 7-2523
 Orval Ruckett, Montana, arrived Saturday for a visit with his son, Darrel and family.
 Mrs. George Buskirk was a Friday visitor in the Clark Buskirk home, Omaha. She accompanied them to Wakefield and all attended the fellowship dinner at the Christian church honoring Evangelist Cy Welch, Footsville, Wis.

Legion Auxiliary
 Plans for a Christmas party were completed at a meeting of Randolph Legion Auxiliary Tuesday night at the Legion hall. The party will begin with a covered dish Dec. 11 and will include members of both the Legion and Auxiliary. Each one is to bring a 50c exchange. Gifts for five boys and five girls were sent to the girl shop at Lincoln Veterans hospital. Mrs. Harold Rohde presided at the business meeting. Lunch was served by Mrs. Rohde and Mrs. Roy Gibson.

Pock New President
 John Pock has accepted the presidency of Randolph community club for the coming year. Vernon Viergutz was elected to the post at their annual election of officers several weeks ago but declined.

Parents Night
 Despite poor weather conditions, Parents Night at the Randolph Public school last Tuesday night was well attended. Seventy-four families were represented.

16 Games Scheduled By St. Frances Cagers
 Basketball practice for St. Frances High is now in full swing with 16 games scheduled for the season. First team prospects will be Charles Tunkin, Richard Wurdinger, Dick Marx, John Leasley, Clarence Wattier, Herman Nordhus, Gene Gubbs, LaVern Scott, Leon Schler, and Ricky Kelsch. Besides the first team material there are 17 others out for basketball.

2,000 Attend Annual Pancake Day at Randolph
 Approximately 2,000 enjoyed Randolph's Pancake Day, sponsored by the Community club, Saturday at the city auditorium. Free pancakes were served by the members of the club from 3-8 p.m. Prizes were donated by Randolph businessmen. There was a pancake eating contest. Participants for this contest

Legal Publication
 County Court of Wayne County, Nebraska, Estate of Neil Nelson, Deceased.
 Notice is hereby given that a petition has been filed for the final settlement of the estate of Neil Nelson, deceased, and that a hearing will be held on the said petition at 10:30 o'clock A. M. on the 14th day of December, 1955, at the County Court House, in the City of Wayne, Nebraska.

Legal Publication
 County Court of Wayne County, Nebraska, Estate of Neil Nelson, Deceased.
 Notice is hereby given that a petition has been filed for the final settlement of the estate of Neil Nelson, deceased, and that a hearing will be held on the said petition at 10:30 o'clock A. M. on the 14th day of December, 1955, at the County Court House, in the City of Wayne, Nebraska.

Legal Publication
 County Court of Wayne County, Nebraska, Estate of Neil Nelson, Deceased.
 Notice is hereby given that a petition has been filed for the final settlement of the estate of Neil Nelson, deceased, and that a hearing will be held on the said petition at 10:30 o'clock A. M. on the 14th day of December, 1955, at the County Court House, in the City of Wayne, Nebraska.

Legal Publication
 County Court of Wayne County, Nebraska, Estate of Neil Nelson, Deceased.
 Notice is hereby given that a petition has been filed for the final settlement of the estate of Neil Nelson, deceased, and that a hearing will be held on the said petition at 10:30 o'clock A. M. on the 14th day of December, 1955, at the County Court House, in the City of Wayne, Nebraska.

Legal Publication
 County Court of Wayne County, Nebraska, Estate of Neil Nelson, Deceased.
 Notice is hereby given that a petition has been filed for the final settlement of the estate of Neil Nelson, deceased, and that a hearing will be held on the said petition at 10:30 o'clock A. M. on the 14th day of December, 1955, at the County Court House, in the City of Wayne, Nebraska.

Legal Publication
 County Court of Wayne County, Nebraska, Estate of Neil Nelson, Deceased.
 Notice is hereby given that a petition has been filed for the final settlement of the estate of Neil Nelson, deceased, and that a hearing will be held on the said petition at 10:30 o'clock A. M. on the 14th day of December, 1955, at the County Court House, in the City of Wayne, Nebraska.

Legal Publication
 County Court of Wayne County, Nebraska, Estate of Neil Nelson, Deceased.
 Notice is hereby given that a petition has been filed for the final settlement of the estate of Neil Nelson, deceased, and that a hearing will be held on the said petition at 10:30 o'clock A. M. on the 14th day of December, 1955, at the County Court House, in the City of Wayne, Nebraska.

Legal Publication
 County Court of Wayne County, Nebraska, Estate of Neil Nelson, Deceased.
 Notice is hereby given that a petition has been filed for the final settlement of the estate of Neil Nelson, deceased, and that a hearing will be held on the said petition at 10:30 o'clock A. M. on the 14th day of December, 1955, at the County Court House, in the City of Wayne, Nebraska.

Legal Publication
 County Court of Wayne County, Nebraska, Estate of Neil Nelson, Deceased.
 Notice is hereby given that a petition has been filed for the final settlement of the estate of Neil Nelson, deceased, and that a hearing will be held on the said petition at 10:30 o'clock A. M. on the 14th day of December, 1955, at the County Court House, in the City of Wayne, Nebraska.

Legal Publication
 County Court of Wayne County, Nebraska, Estate of Neil Nelson, Deceased.
 Notice is hereby given that a petition has been filed for the final settlement of the estate of Neil Nelson, deceased, and that a hearing will be held on the said petition at 10:30 o'clock A. M. on the 14th day of December, 1955, at the County Court House, in the City of Wayne, Nebraska.

The Wayne (Nebr.) Herald, Thursday, November 24, 1955
 Kai was an afternoon visitor Mrs. Darrel Pickett. Mrs. P. R. Giesler, Beatrice, was assisting at the Pickett home for a few days. Mr. and Mrs. Benny Franson, Lyons, spent Wednesday at Richland Myers'. Mr. and Mrs. Louis Hinsen and family were Monday evening visitors.

Farmers Union Slates Annual Supper Dec. 2
 Annual cooperative supper of Leslie Farmers Union will be at the C. W. McGuire home Dec. 2. Election of officers will be held.

Mr. and Mrs. Dick Utecht
 Mrs. Henry Tarnow, Mrs. Will Korth and Mrs. Verne Girtsos were luncheon guests of Mrs. Fred Terry, Wisner, Thursday honoring her birthday.

Mr. and Mrs. Dick Kall
 and daughters were Sunday evening visitors at the Donald Kai home near Waterbury.

Mr. and Mrs. Louis Hansen
 and family were Sunday evening visitors at Ed Krusemark's.

Mr. and Mrs. Darrel Thomsen
 and family spent Sunday evening at Albert Kai's and Friday evening at Ed Krusemark's.

Mr. and Mrs. Emil Tarnow
 were at the Herman Baker home for Sunday evening.

Mr. and Mrs. Henry Tarnow
 spent Sunday afternoon at the Fred Puls home.

Mr. and Mrs. Robert Hansen
 and son were Sunday dinner guests at Billy Hansen's.

Mrs. Mary Hansen, Arnold Brudigan and Mrs. Ervin Clinkenbeard
 were Sunday dinner guests at Jack Schroeder's, near Laurel.

Mr. and Mrs. Wendell Korth
 and sons were Sunday visitors at the Herby Hansen home, Pierston, Ia.

Mr. and Mrs. Billy Hansen
 and family and Mr. and Mrs. Joe Wilson were Sunday evening guests at Jack Schroeder's near Laurel.

Mr. and Mrs. Donald Dolph
 were Sunday dinner visitors at Dan Dolph's.

Mr. and Mrs. Dan Frevert
 visited in their home Friday evening.

Guests in the Florenz Niemann
 home for dinner last Tuesday were Mr. and Mrs. Ray Rogg.

Mrs. A. L. Ireland
 visited in the Roy Spahr home last Wednesday and Thursday. She and the Spahrs

Cars, Trucks Registered

- New Cars**
 Dean H. or Norma Backstrom, Wayne, Pontiac - 1954
 Albert M. or O'Faun Kern, Wayne, Pontiac - 1954
 Carl Lage, Wayne, Mercury - 1954
 Everett of Louise Newman, Winside, Chevrolet - 1954
- Used Cars**
 1955
 First Nat. Bank, Wayne, Ford - 1954
 Steve H. Schmidt, Wisner, Ford - 1954
 Ben Cross, Wayne, Mercury - 1953
 Ernest L. Meyer, Wayne, Chry. - 1952
 Paul Letting, Winside, Chevrolet - 1952
 Otto J. Test, Wayne, Ford - 1952
 Harry Schulz, Wayne, Chevrolet - 1951
 Wendell Korth, Wakefield, Ford - 1951
 Edwitt L. or Darlene Koehler, Wayne, Chevrolet - 1951
 Merold R. Claussen, Carroll, Plymouth - 1951
 Edgar E. Swanson, Winside, Ford - 1950
 Mr. or Mrs. L. Roland Harsch, Wayne, Plymouth - 1950
 William H. Jacobsen, Wayne, Oldsmobile - 1948
 Pritchard Brothers, Winside, Willys pu - 1946
 Mrs. Betty M. Juhl, Wayne, Chev. - 1946
 Mrs. Dorothy Jorgensen, Wayne, Dodge - 1930
 Edwin Lucas, Randolph, Ford t - 1930



Watch your Step!

Be sure you get a Modern Truck

Look for new CONCEALED SAFETY STEPS — a mark of today's most modern trucks that new Chevrolet Task-Force trucks bring you. They stay clear of snow, mud and ice to give you firmer, safer footing.

This is just one of the ways you're way ahead with new Chevrolet trucks! They're today's most modern trucks. And that holds good under the hood! These handsome huskies offer you the shortest stroke V8's* in any leading truck. Or, you can have the most modern valve-in-head six on the market. All engines have a 12-volt, electrical system. You get today's most modern cab, too — with advanced features like the sweeping panoramic windshield, bigger side and rear windows, and High-Level ventilation. And you get the most modern truck styling going. Chevrolet trucks are Work-Styled for your job.

Still another thing you'll like about new Chevrolet trucks is their modern Ball-Bearing steering. It makes turning and maneuvering far easier. Come in and see why anything less is an old-fashioned truck! *V8 standard in L. C. F. models, optional in most other models at extra cost.

New Chevrolet Task-Force Trucks

Watch the Deal! Why pay more for an old-fashioned truck? New Chevrolet trucks wear the same low price tags. No increases! Come in and check our dollar-saving deal on the most modern model for your job!

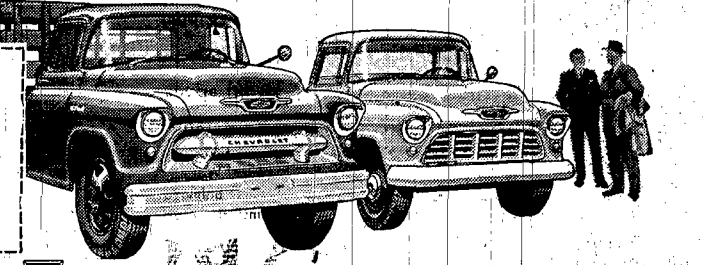

CHEVROLET Year after Year America's Best Selling Truck
CORYELL AUTO COMPANY
 Wayne, Nebr. Phone 152

First National Bank
 200 Main Phone 7

When You Think of **SHOES** Think of **MAN'S WAYNE'S FAMILY SHOE STORE**

112 East 2nd Street

'I See by The Herald'

Items about Wayne folks you know

Mr. and Mrs. Warren Ellis entertained last Friday in honor of Diane's birthday. Mr. and Mrs. Harvey Larsen, Mr. and Mrs. W. L. Ellis, Mr. and Mrs. Victor Knesche and Ranie, and Mr. and Mrs. Ken Nuerberger.

Mr. and Mrs. D. H. Cunningham, Sioux City, spent Friday in the Mrs. C. H. Fisher home. The Cunninghams came to attend Frank Morgan's funeral.

Last Sunday Mr. and Mrs. Maurice Fisher, Linda, Terry and Steve, Mr. and Mrs. Everton Fisher, Concord, and Mrs. Grace Dawson visited in the Ron Fisher home, Cozad.

Maurice Fisher and Everton Fisher, Concord, went to Omaha last Monday. Mrs. Arlen Fitch and daughter went to Fremont on business Friday.

Mr. and Mrs. Morris Sandahl and Jennifer called in the Melvin Froehlich home last Wednesday.

Last Sunday evening Rev. and Mrs. Albert Gray entertained Mr. and Mrs. Archie Wert and Rev. Santiago Ibarra.

Mr. and Mrs. Jerold Daniels called in the Roy Daniels home Thursday evening.

Sunday dinner guests in the Gerald Hasebroock home were Mr. and Mrs. Ted Pulley and family, Meadow Grove, and Mrs. Leila Hasebroock.

Deanna Baier was an overnight guest of Phyllis Cook Wednesday. They attended the state music clinic in Hastings Thursday.

Mr. and Mrs. Henry Langenberg, Hoskins, visited Mrs. Walfred Carlson last Wednesday.

Last Tuesday afternoon Mr. and Mrs. Gilbert Dangberg, Winside, called in the Mrs. Walfred Carlson home.

Mr. and Mrs. O. L. Black returned last Monday evening because Mr. Black fell and broke his foot that morning. They had been visiting their daughter, Mrs. Donald Belter and family, the past two weeks.

John Baker went to Wakefield and Concord last Friday.

Last Sunday Mr. and Mrs. William Baker, Concord, visited in the John Baker home.

Mr. and Mrs. R. H. Banister will spend the weekend with Mr. and Mrs. Richard Banister, Lincoln.

Mrs. Detlef Bahde and Leona spent the weekend in the Ruth Hillverstien and Madeline Kauffman homes, Omaha.

Mrs. Art Auker attended social circle in the Mrs. William Cary home, Winside, last Wednesday.

Mrs. Lula Backstrom, Mrs. J. P. Turner and Francis Turner, Wakefield, spent the weekend in Des Moines.

Mr. and Mrs. Paul Garrett, Lincoln, were dinner guests at the Ed Bahe home Sunday.

Mrs. Gertrude B. Phillips left Friday to visit her brother, Edward Barel, Storm Lake, Ia.

We Welcome Suggestions

★ IT'S only human to look for a pat on the back, but we are one organization that is equally receptive to criticism of the constructive kind. As we look at it, we are a service organization. Our clients and our critics are those we serve; we respect their rights and we want them to have the things they want and to do things the way they like. So—never hesitate to tell us where and how our service can be improved. You will find us more than willing to accept any feasible suggestion.

Beckenhauer Service
Phone 292 Wayne

Get the "3 EXTRA EGGS" Feed Fortified with LayLac



Make "3 extra eggs per month" your goal for each hen in your flock! Let LayLac, Gooch's exclusive "egg-maker" additive, help you—as it has already helped many other good flock managers who feed

GOOCH'S BEST Laying Feed

All GOOCH'S BEST Laying Feeds contain LayLac! Plan now to boost your egg profits by putting your hens on the "3 extra eggs" feed! See us for the type of Gooch Laying Feed that's best for your feeding plan!

GOOCH'S BEST FEEDS

Sherry Bros. Produce

CONCORD WAYNE CARROLL

Mr. and Mrs. Carl Thomsen visited in the S. J. Hale home last Tuesday.

Mr. and Mrs. Richard Jugel were dinner guests in the Carl Ruchman home last Sunday for Gerald's birthday. Twenty-four other relatives were also there.

Mr. and Mrs. Henry Bush, Gary and John Kay and Lavone Peters, Pliger, were last Monday dinner guests in the Alfred Jugel home.

Gary Kay spent the weekend in their home.

Mr. and Mrs. Ed Glassmeyer returned from a two-week visit in the Tom Tuckek and Frank Glassmeyer homes in Hemingford.

Allan Perdue was a last Wednesday afternoon guest in the Alfred Jugel home.

Mr. and Mrs. Earl Baird and Jerry, Omaha, were last weekend guests in the home of Mrs. Charles Baird.

Mr. and Mrs. Russell Baird were Thursday evening guests.

Mr. and Mrs. Earl Bennett and family and Mr. and Mrs. Warren Austin and family, were Friday supper guests in the Ralph Austin home.

Mrs. Fritz Thun and Betty Jean, Salina, Kan., were Tuesday and Wednesday guests in the Charles Austin home.

McDONALD'S WINTER COAT SALE!

Starts Friday, Nov. 25



All Women's Coats Drastically Reduced to Save You Money!

We Have Some Beautiful Coats for You to Pick from. Come See, Select Now!

- Group I** Values to 29.95 **\$ 23**
- Group II** Values to 39.95 **\$ 33**
- Group III** Values to 49.95 **\$ 43**

Fall Dresses Reduced

Hurry in for Best Selection! Beautiful Fall and Winter Dresses that Have Been Cut in Price to Clear! Hurry!

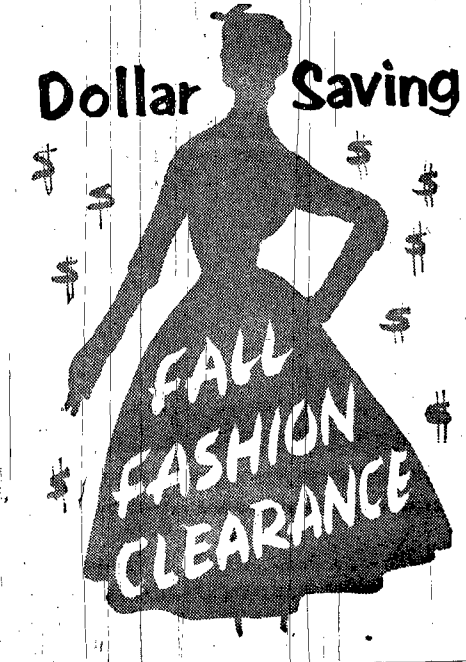

- Group I** Values to 5.95 **\$ 4**
- Group II** Values to 8.95 **\$ 6**
- Group III** Values to 12.95 **\$ 8**



LUGGAGE

is a gift that special person will enjoy for years to come!

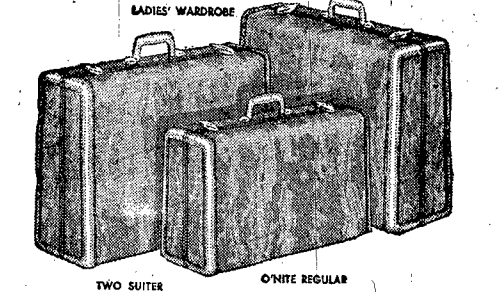

Streamlite Samsonite Luggage

defys wear! Keeps its new look!

O'nite case 1950 plus tax Women's wardrobe \$25 plus tax Men's 2. \$25 plus tax

Better-than-leather finish resists marring; soil sponges off readily. Luxurious but sturdy rayon linings. Saddle tan, Colorado brown, Bermuda green, admiral blue, rawhide.

Samsonite train case for women

17.50 plus tax

Holds 42 traveling needs! Handy mirror in lid; plastic tray is removable. Dust and moisture can't get in.

Streamlite Samsonite quick tripper

19.50 plus tax

Lets him pack more clothes in less space without wrinkling. What a value!

Water repellent grey luggage accented with maroon binding

Train case **498** Weekend case **498** Pullman case **695**

Three-piece set . . . **15.95**

Plastic coated grey fibre coverings have wide, double-stitched maroon bindings. Water repellent linings. Rayon pockets in lids. Brass plated hardware. Buy the set . . . save!

1	2	3
4	5	6
7	8	9
10	11	12
13	14	15
16	17	18
19	20	21
22	23	24
25	26	27
28	29	30
31		

We will be open nights until 9:30 on the dates shown in black for your shopping convenience

1	2	3
4	5	6
7	8	9
10	11	12
13	14	15
16	17	18
19	20	21
22	23	24
25	26	27
28	29	30
31		

At The Wayne County Schools

Wayne High ...

Kindergarten
Dougie Ritze and Dougie Farrens both had birthdays Nov. 14. Dougie Ritze brought treats for the morning class and Dougie Farrens for the afternoon group. Mrs. Mrs. Ritze, Mrs. Farrens and Debbie were visitors.

John Matson brought birthday treats Nov. 15 and Jane Meyer on Nov. 18. All were celebrating fifth birthdays except Dougie Farrens, who was six.

First Grade
We saw the film, "Care of Pets" Monday morning. It showed how to care for a canary, fish, a dog and a kitten.

Tuesday morning we visited the City Library. The librarian read us the story, "The Duchess Bakes A Cake." We also saw a film and looked at some of the new library books. We enjoyed our visit.

The Cardinals finished their readers and are now reading "Guess Who."

We began working on a circus unit this week. The library table has a circus tent with the animals and "clowns" which could be seen at a real circus. The number train now is carrying circus animals. The animals and tent were brought by first graders. We are making a booklet about the circus.

Books for story-time were brought by Jane Von Seggern, Connie Fitch, Debbie Wright, Bobbie Morris and Paulette Morchant.

Our teacher made recordings of our reading on the tape recorder Thursday and Friday. We each read a story, then listened to our voices on the recorder.

Second Grade
The second grade visited the City Library Wednesday afternoon in observance of Book Week. Mrs. Aldinger read the book "The Duchess Bakes a Cake" and showed two film strips.

The second grade saw a film on Boston Thursday.

Billy Horrell celebrated his eighth birthday by bringing treats to his classmates Friday.

The following people had perfect attendance during the second six week period: Ruth Ann Baier, Billy Horrell, Roger Johnson, Terry Mastaway, Beth Ann Mau, Debrae Pottson, Janet Preston, Jimmy Sommerfeld, Stacy Swinney, Keith Tietgen, Kathy Voor-

hes, Suzanne Warner and Julia Woods.

Janet Preston brought cupcakes to her classmates Friday. She was celebrating her eighth birthday.

Third Grade
Safe Way club officers chosen at the Friday meeting were: Steve Barjenbruch, president; Tom Addison, vice president; Nancy Wolters, secretary; Linda Seymour, program chairman; Debbie Wightman, Linda Corbit and Patty Perdue, cheerleaders. Helpers for the week were Kenny Faulson, T. Dirk Lueders, Janet Van Auker, Linda Weible, Terry Karel and Debbie Wightman.

The third grade birthday chart shows four birthdays in November. T. Dirk Lueders, Nancy Wolters and Sally Fisher celebrated their birthdays with parties at school. Each brought treats for the class.

Mrs. Arthur Wolters and Mrs. H. D. Addison attended Safe Way club meeting Friday. Mrs. D. S. Wightman was a Thursday visitor.

The class presented a walking rehearsal of the play, "Why Be a Doof" by fourth graders Friday. Those taking part in the play were: Linda Corbit, Ricky Bornholt, Sandra Oles, Ginny Wild, Janet Van Auker, Jayne Echtenkamp, Holly Willert and T. Dirk Lueders.

Fifth Grade
Our second spelling contest ended this week. Kenny Oles' team defeated Terry March's team 41-35.

Stand-up turkeys, suitable for table decorations were made in art class Friday.

Six-week tests were given this week in arithmetic and science. In the arithmetic test Terry March had a score of 98 percent, Wilma Marra and Karen Hurd had the next highest with a 96 percent.

Ten people had perfect scores in the 100-word test given Friday. These words are the six-week test and are given at one sitting. Those who had 100 percent were: Marlene Johnson, Jayne Hughes, Karen Hurd, Lynette Jewell, Terry March, Wilma Marra, Kenyith Oles, Cynthia Sommerfeld, Linda Thompson and Marilyn Nuernberger.

Four pupils missed only one of the 100 words. They were: David Zumbur, Dennis Breitbarth, Donna Echtenkamp and Dewayne Harrison.

Eighth Grade
We are now studying percent in arithmetic.

We enjoy reading orally poems in our reading class.

In language class we are studying transitive and intransitive verbs and active and passive voice. We took our achievement tests this week.

Aleanna Diamond brought some iron ore which she got when she was in Wisconsin.

We have started the unit on "Weather" in science.

Robert Dean-Proett was absent due to illness.

Rural Schools ...

District 64
Betty Mohlfeld, teacher
Those with perfect attendance for the year are Wayne and Douglas Lueders, Carol Ann and Myron Grest and Shirley and Evelyn Greve.

We are starting a hot lunch program. Each pupil is responsible for a hot dish one day each week.

We have finished "Mystery Tour" during opening exercises. We have a school newspaper which seventh and eighth graders publish. We had mothers visit our school Nov. 7 for American Education Week. Mrs. Harry Gust, Mrs. Wallace Giese, Mrs. Harvey Lee and Mrs. Delbert Lueders attended. Mrs. Gladys Porter has also visited our school.

Shirley Greve treated the teacher and pupils on her birthday.

District 32
Mrs. Cordelia Chambers, teacher
Our beginners have completed their readiness books and are now reading a pre-primer.

Eight students have perfect scores in weekly spelling tests. They are Betty Jean, Shelia, Sandra and Peggy McGuire, Korbie Von Seggern, Carol Bartelman and Curtis and James Downey.

We invited patrons of the district to the school for American Education Week. We conducted one class for each grade. Exhibits of student work were on display. Lunch was served.

District 88
Marcia Wittmer, teacher
Pupils with perfect attendance are Randy Baker, Billy Swinney, Ronnie Tennie and Rosemary Gilliland.

Those with perfect spelling tests

Vol. 81 - No. 29

Wayne, Nebraska, Thursday, November 24, 1955

Sec. 3 - Pages 1 to 6

were Duane and Verdel Backstrom and Rosemary Gilliland.

We are enjoying a new recitation and reading table and a new projector and screen. Beginners are working on their second reading readiness book.

Second Grade is studying the library in social studies. Third grade is studying foods and making booklets. Fifth grade is studying the southeastern states while sixth grade is studying the Near East.

Parents visited the school during Education Week. Mrs. Gladys Porter was also a visitor.

Duane Backstrom treated the pupils and teacher for his birthday.

SOUTHWEST

Wakefield
Mrs. Lawrence Ring
Phone Atlas 7-2620

Rural Home Society
Mrs. Dick Sandahl entertained 13 members of Rural Home Society and one guest Mrs. Morlin Hasenkamp, Thursday afternoon. Lavonne Bichel came after school. Roll call was ways to use leftovers. Mrs. Effie Suher was in charge of entertainment. Plans were made for Christmas. Clothing was received for Nebraska Children's home. Mrs. Merle Ring will have the Christmas party Dec. 15.

Mr. and Mrs. Merlin Hasenkamp and Diane Marie and Mr. and Mrs. Dave Anderson, (Pete and Gary, Pilger and Mrs. F. A. Suber were Sunday afternoon visitors in the John Suber home.

Mr. and Mrs. C. L. Bard were with Mr. and Mrs. C. A. Bard as dinner guests Sunday in the Marjorie Ring home, Wayne.

Sandra and Richard Ring were with their grandparents Sunday while their mother was at Wausau for a Sunday school teachers meeting. Mrs. Dick Sandahl also attended.

Larry Ring, who is employed in Omaha, spent the weekend with home folks.

Nancy Ring is spending a few days in the C. L. Bard home. Richard and Robert were there Monday.

Sunday dinner and supper guests in the Elvis Olson home were: Rex and Mrs. Melvin Pedersen and family, Mr. and Mrs. Reynold Anderson and Mr. and Mrs. Levi Helgren and daughters.

Mrs. Emil Lund and Mrs. Fred Utecht visited Mrs. Walter Grosc Wednesday afternoon.

Mrs. Emil Lund and Mrs. Ralph Ring and Sandra were with Mrs. Elvis Olson Friday afternoon packing clothing for Rural Home Society.

Mrs. Homer Biermann spent Sunday in the parental Ed Sandahl home. Her husband suffered a broken leg Saturday afternoon and is in the Wayne hospital.

Mr. and Mrs. Lawrence Carlson were at Bob Stanley's Tuesday evening.

Mrs. Dick Sandahl was with Mrs. N. P. Nyberg, Wayne, Saturday afternoon.

Mr. and Mrs. Albert Sandell were in the E. P. Casauwe home Sunday evening. They accompanied Mr. and Mrs. Joe Erickson to visit. Mrs. Sandells near Laurel in the afternoon.

Mr. and Mrs. Earl Lundahl were dinner guests Sunday in the home of her parents, Floyd Spikes, Hartington. Mr. and Mrs. E. J. Lundahl, Joan and Lavene accom-

panied them. They were joined in the afternoon by the Maurice Lage family, Carroll and Lester Smiths, Laura.

Floyd Johnsons were in the Glen Olson home Friday evening. Olsons visited at Billy Hansen's Wednesday evening.

Mr. and Mrs. Alden Backstrom and Douglas were in the Merle Ring home Saturday evening.

Mr. and Mrs. Merle Ring and sons were Sunday dinner and supper guests in the Brice Nicholson home.

Lawrence Carlsons were at Mrs. Alec Carlson's birthday party Wednesday evening.

Margaret Clapper spent Sunday and overnight with Colette Borg. Mr. and Mrs. Borg went to Oakland in the afternoon to visit Ted Carlsons in the Otto Carlson home.

Mr. and Mrs. Lawrence Hanson and Jean were Sunday afternoon visitors in the LeRoy Griesech home, Wayne.

Randy, Rhonda and Rita Olson spent Sunday afternoon with Carol and Butch Mortenson.

Mrs. Charlotte Lundahl was a Sunday dinner guest in the C. R. Ash home.

Mrs. Bud Erlanson began teaching Monday in District 33, four miles south of Sandahl school.

Mr. and Mrs. Jewell Killion were in the Jim Chambers home for Sunday dinner. Mr. and Mrs. Albert Killion were evening visitors.

Mrs. Gordon Bard visited Mrs. Ray Hallgren Friday afternoon. The family was at Harley Bard's for oyster supper that evening together with Alden Johnsons.

Mrs. Olive Lamb, Mrs. Lettie Harmon and Mr. and Mrs. Fred Erickson, Walside, were Sunday dinner guests in the Carl Sandell home.

Mrs. Joe Erickson was with Mrs. Sundell Wednesday evening while their husbands attended a meeting in Wayne.

Mr. and Mrs. LeRoy Lundahl were at Emerson Sunday evening to see the new baby in the Freddie Puls home.

Mrs. Alden Johnson and children were supper guests in the Harold Olson home Thursday for the birthdays of Lowell Johnson and Janice Olson. Both were eight that day.

Mr. and Mrs. Oscar Bloomquist were Sunday visitors in the Joe Johnson home.

The Leonard Roberts family were supper guests Sunday in the Delbert Roberts home.

Mr. and Mrs. Harry Wert were Sunday dinner guests in the Ole P. Nelson home, Wayne.

Mrs. Walter Chinn attended Mrs. Olive Lamb's birthday party last Tuesday afternoon. She was at Ft. Dodge, Ia. over the weekend visiting her aunt.

Mrs. Art Munson and Carroll were in Sioux City Monday and drove around to the scene of the accident on Highway 20.

For Walter Chinn's birthday of Monday evening visitors were: Merlin Bresslers, Ellis Johnsons and Cecil Rhodes.

Mr. and Mrs. Jack Soderberg were in the Charles Ruff home, Sioux City, for supper last Tuesday evening.

Mabel Brudigan, daughter of the Henry Brudigans, is in the Wakefield hospital where she had blood transfusions the first of the week.

Mr. and Mrs. Harvey Smith and children, Wayne, were visitors in the Glen Lundahl home Saturday evening. Mr. and Mrs. Gene Block and children were Sunday dinner guests.

Sholes

By Mrs. Martin Madsen
Phone 48-R14, Randolph

Mr. and Mrs. Martin Madsen visited in the Everett Robins home, Hartington, Sunday afternoon and were dinner guests there. They

Shoes

brought their granddaughter, Sharon, to Wayne where she attends college.

Mr. and Mrs. Lyle Peters and family were Sunday guests in the Otto Peters home.

Mr. and Mrs. James Tietgen and daughters were guests in the Walter Tietgen home Sunday evening.

Mr. and Mrs. Charley Sohn visited in the Bert Borge home, Randolph, Sunday evening.

Mrs. G. D. Burnham visited in the Joe Mattingly home, Sioux City, Saturday.

Mr. and Mrs. Walter Gubbels and sons and Mr. and Mrs. James Lucas were Sunday dinner guests in the Charlie Leploff home.

Mrs. Edna Conyers, Randolph,

TRY THE WANT AD

COLUMN IN THE HERALD

for your family health's sake...

THE ALL-NEW GOLDEN MONARCH Filter Queen

HOME SANITATION SYSTEM PURIFIES THE AIR YOU BREATHE!

Only Filter Queen has the sanitary filter cone... the real secret to home sanitation. Doctors, hospitals, nurses acclaim it... thousands of users praise this valuable aid to family health. Now you must see it to believe all the many new advancements only Filter Queen offers. It is the most beautiful model we have ever introduced... will be shown in your home, without cost or obligation. Phone today.



MAIL COUPON TODAY

FREE! Please deliver my free gift and show me how to keep my home healthier and happier. I understand I am under NO obligation.

NAME: _____ ADDRESS: _____ CITY: _____ STATE: _____

DISTRIBUTED EXCLUSIVELY BY: "The Family Gift Center"

L. W. McNatt Hardware 203 Main Wayne Phone 108

GET THIS GENUINE American Flyer ALL-ELECTRIC TRAIN with your NEW automatic DRYER

This is a Factory-Sponsored pre-Christmas offer Just look how much you save:

Model DE9 Electric Dryer	Value	169.95
"American Flyer" train	Value	\$62.30
Total Value		232.25
YOU PAY ONLY		169.95
YOU SAVE ..		\$62.30

* Gas Dryer slightly higher

Terms can be arranged

WITH the dryer season at its peak, and Christmas just around the corner, here is a factory-sponsored combination offer that does you a big, fat favor at a most opportune time. The Dryer is a full-featured 1956 Model that brings you the highest efficiency and built-in quality in the entire dryer industry. From an operation and service standpoint, there is no finer dryer on the market.

Includes: Powerful Locomotive and Tender with piston action Refrigerator Car, Tank Car, Gondola and Caboose Cars have real handking couplers 260 inches of track Trestle Set 50 watt transformer Remote Control Billboard White

FREE TICKETS for Children Train Rides Nov. 25-26 at the Family Gift Center

L. W. McNatt Hardware

Wayne, Nebr. Phone 108

GIFTS for the WHOLE FAMILY

- ★ TOILETRIES
- ★ TOYS
- ★ APPLIANCES
- ★ CANDY
- ★ STATIONERY
- ★ ACCESSORIES

AT OUR Rexall DRUG STORE

KIDS - GET FREE TRAIN RIDE TICKETS HERE

Su	Mo	Tu	We	Th	Fr	Sa
4	5	6	7	8	9	10
11	12	13	14	15	16	17
18	19	20	21	22	23	24
25	26	27	28	29	30	31

WE WILL BE OPEN NIGHTS ON DATES SHOWN IN BLACK

Griess Rexall Store

WAYNE, NEBR.

OUR FINEST light arctic 595

The ideal all around weatherproof for all the family! Leather-grain Finish - Fleck-Lining Mail - Women's Children's Sizes

VAN'S

"Wayne's Family Shoe Store"

Wayne, Nebr.

Make Van's Your Headquarters for Family Footwear

Boy's Combat Boots

595 to 795

Thermo-Lite THE INSULATED WEATHERPROOFS

Women's 4.95 Girls' 3.95

MOJUD NYLONS Special Pair 88c

CASUAL WITH STYLE!

Step right in...the fit's fine!

\$7.95

WESBORO

"THE VERY NEAREST TO YOUR MEN'S SHOES"

No doubt about it... here's economy \$8.95 and smart style.

Engineer Boots 1495

Women's 4.95 Girls' 3.95

Women's 3.95 Girls' 2.95

Handbags

We've a Wide Choice of Styles and Finishes

\$1 to \$1.98

VAN'S

Wayne's Family Shoe Store

210 Main Wayne



The Herald's *Farm and Home* Building Section



A Home with A Warm, Friendly Feeling

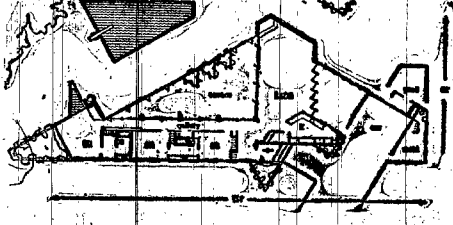
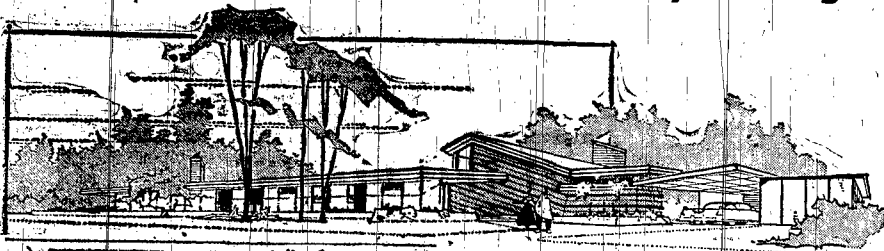

The Wayne (Nebr.) Herald, Thursday, November 24, 1955

Thrilling News—from FRIGIDAIRE!

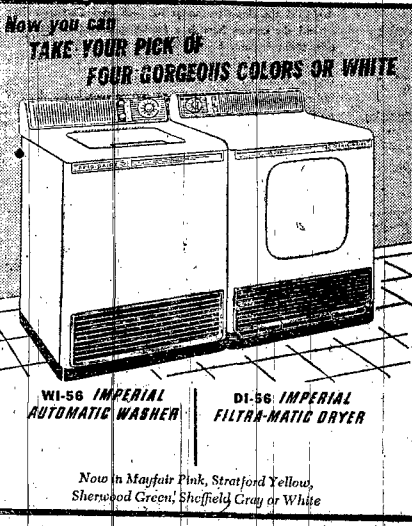

FRIGIDAIRE IMPERIAL Laundry Match-Mates

Pick them in all white, or in a two-toned effect with white top and cabinet in your choice of four colors, as you prefer. There's sure to be an arrangement to please your taste in color. Both of these Laundry Match-Mates are styled to match each other and engineered to work together to give a new lift to your washdays.

AUTOMATIC WASHER

flexible beyond belief

Here's the Automatic that's like "2 washers in 1." Set the new Econo-Dial for the size of the load, the kind of fabrics to be washed. Working hand in hand with the Select-O-Dial, the amount of water used and length of washing time are automatically adjusted. Saves gallons of hot water. This Automatic spins pounds more water out of clothes, to cut down on drying time and cost. Even more, it washes clothes cleaner than you ever dreamed. See it today.

FILTRA-MATIC DRYER

no venting needed

You won't spend a penny for plumbing or venting, for the amazing Filtrator handles objectionable hot, moist air and lint. Dries clothes soft, fluffy—to the exact degree of dryness you want. Ozoné "sunshine" lamp gives sweet, clean, fresh smell to the clothes.

Come in—and win! \$100,000 "FREE-FOR-ALL" CONTEST
YOU MAY WIN a Cadillac Convertible—a Buick Riviera—a Chevrolet Station Wagon—or a complete Frigidaire Kitchen and Laundry—or any of 150 other big-value prizes of Frigidaire 1956 New Lift To Living Appliances!
Come in now... for full information and your FREE ENTRY BLANK!

You get the BEST when you buy FRIGIDAIRE

Kugler Electric Co.

30 YEARS WITH FRIGIDAIRE "We Service What We Sell"

The home builder who is looking for something different, yet practical, will find it in a new design by Mackie and Kararath of Houston, Tex. Two young architects who have earned an international reputation for both residential and commercial work.

The design illustrates how asbestos siding shingles can impart charm and distinction to better class homes. It was one of six prepared by outstanding architects in various parts of the nation.

The Houston architects' primary goal was to create a house "with an intimate, warm, friendly character, built to a personal scale."

Facing inward on a triangular terrace: the house includes a sleeping area of three bedrooms and a large glass-fronted living and dining room. In the sketch above the sleeping area is seen on the left. The flat-roofed wing has exterior siding of asbestos board. The living room wing rises to story-and-a-half height on the terrace exposure and slopes to single-story level for an adjoining utility room and carport.

The living room-utility room section features an unusual use of asbestos siding, a material which has gained great popularity because of its performance qualities and smart new styling. On the sidewalls of greatest height, the shingles are applied at an angle paralleling the eaves to add interest and to emphasize the angular plan-

ning. Redwood mouldings occur between every two courses of strength and permanence, the redwood moulding contributes a warm naturalness.

The asbestos products, of a mineral origin, give a feeling of shingles.

Because of their durability, fire-safety and attractive colors, asbestos shingles have become one of the most popular of siding materials. A companion product, rigid asbestos roofing shingles, has been a favored roof protection for more than fifty years.

Exposed Ceilings Liked

Use of exposed beams and exposed wooden ceilings has become so popular in contemporary home design that sale of these grades of fir and hemlock lumber has tripled in the past year, the West Coast Lumbermen's association reports. New types of rez, varnish and paint stains make it possible to retain all the natural beauty, grain and texture of these woods in the ceilings and beams which aid in the general decorative scheme of new homes.

Work Bench Tip

A good way to prevent a work bench from wobbling is to install rubber heels on the legs. These will compensate for uneven floors or bench legs and lessen power-tool vibrations.

HERE'S HOW... MAKE A TOY CHEST BENCH

A toy-chest-bench is an attractive piece of furniture for the children's room. The chest is made of lumber one inch thick. The ends back may be glued panels of hardwood plywood or two boards. The curved back is cut with a coping saw. All pieces should be sanded before assembly. Assemble the end panels to the front, rear and bottom panels, using glue and 6-penny finishing nails. Then install two 2-1/2 by 18-1/2 inch seat sup-

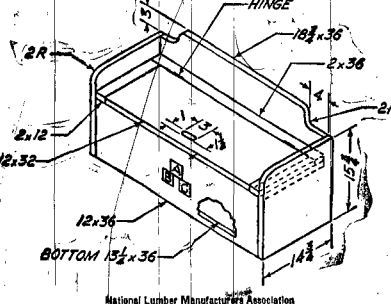

National Lumber Manufacturers Association

CHILDREN... Get Free Tickets Here

FOR RIDES ON THE LITTLE TRAIN FRIDAY - SATURDAY, NOVEMBER 25 - 26

TIME PAYMENTS for Building • Remodeling • Repairs FULLERTON LUMBER COMPANY

113 S. Main Dave Theophilus, Mgr. Wayne



BUILDING or REMODELING?

SEE TIEDTKE FOR

- Plumbing
- Heating
- Youngstown Kitchens
- Wiring
- Appliances

GENERAL ELECTRIC — AMERICAN STANDARD

TIEDTKE

PLUMBING, HEATING & APPLIANCES



Even Moderate Price Houses Now Offer Deluxe Features

Even comparatively moderately priced homes can have custom-built features. This is demonstrated in a new housing development in the Philadelphia area, described in a recent issue of the Correlator, official organ of the National Association of Home Builders.

The Lawrence Park development, to be built at a cost of \$30,000,000, will have 1,200 homes. All will be air-conditioned. Lower levels of the split-level houses will have a spacious living room, dining room and modern kitchen. On the upper level there will be three large bedrooms and a ceramic tile bath. The accent, according to Builder Ralph Bodek, will be on "comfort and gracious living." The price—just under \$15,000.

The exteriors are a very attractive combination of brick and as-

bestos siding. A typical home is finished with brick walls on the single level unit and on the lower portion of the two-level unit. The upper part of the two-level section has an attractive exterior finish of asbestos siding in smart new colors and designs.

Kitchens feature a built-in, eye-level oven and burner unit with a table-top range. Giving the kitchens a warm, natural look are cabinets of birch, trimmed with antique copper. The heating system is gas-fired forced air. To provide summer and winter air conditioning, units of two-ton capacity are supplied. Both air conditioning and heating are automatically controlled for fluctuating weather conditions. There is hardwood

flooring throughout the home except in kitchen and bath.

Included in the development will be a massive shopping center which will contain all the stores necessary to make Lawrence Park a self-sustaining community. The shopping center will have parking space for 3,300 cars.

Modernization Means More When Colors Are Correct

"Good color is just as important to an old house as to a new one," says Practical Builder magazine. "In fact, 'modernization' is just a name without real significance if it fails to include an attractive color-styling job on the remodeled house, without good color, the house simply can't be truly modern."

"Home-owners can be as colorful as they wish without running up remodeling costs. A white roof costs little more than a black one, a icy green asphalt shingles about the same as mist blue or smoky gray. Some of the deep tones in paint are more expensive than white, but the difference isn't prohibitive—and what is true of roofing and paint is true of most finishing materials. Color costs so little more, so why not use it?"



First step in color styling, according to the magazine, is to select the roof color, as "the roof generally is the largest single area visible to the eye."

"A light, bright roof makes a house appear taller than it is. A dark roof makes the house seem lower. Use light-colored asphalt shingles on one-story houses, deeper colors on two- or three-story houses."

Next step is to choose the siding color. Practical Builder suggests, "If the roof is light in color, keep side walls light. If the roof is medium to dark, keep walls the same. In general, there should be no sharp contrasts between the roof and the siding. Paint trim the color of the siding or in a tone of the siding door."

For a focal point, the magazine recommends bright, cheerful accent color for the entrance door, but not for the windows. "Windows are 'eyes' to homes. Keep them warm and inviting. Paint sash and frames in the trim color, not the accent color. Exception: picture windows are frequently painted in the accent color."

How to Get FHA Loan for Home Modernization

The government-sponsored and insured FHA Title I loans for home modernization and repairs are available through most banks and building and loan associations.

You fill out a simple application form. It is processed by the lending agency. Within a few days your check is ready.

No mortgage is involved. No title examinations. No extra charges or service fees.

Loans range from \$100 to \$2500. You can take from six months to three years to repay.

Interest by the government, is five percent, deducted at time loan is made.

Homes Per Farm

Although number of U. S. farms will decline by 10,000 each year until 1975, Stanford Research Institute estimates number of dwellings per farm will increase. Reason: farms will become larger economic units and housing will be provided as inducement. Farms are large consumers of lumber. Brite Douglas fir, which is easily used for repair and maintenance of fences, out buildings and homes, with a minimum of tools.

Love of Wood

Most people love wood in their homes because it is warm, soft-toned and livable. Some home owners, faced with the problem of selling their older homes when business and employment requires them to move, have discovered the real appeal of wood. By installing a wall of rich-looking fir paneling in a living room or den, they have found ready buyers and best of all, have been able to get more money for their homes.

Are You The Woman In This Picture?



"Life's one long scrub," said Mrs. Best. "I never get a moment's rest. With seven children and a pup, I'm sweeping, washing, cleaning up. With brooms and brushes, pails and mops. A mother's work just never stops. I wish there were some simpler way To keep our home all neat and gay."

You Needn't Be If You Let Carhart's Floor Your Home

KENFLEX

VINYL ASBESTOS TILE FLOORS

Defies grease, dirt and wear

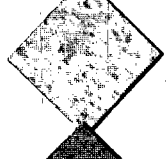

CARNIVAL

Gay, mottled colors that lend cheer to any room.

\$6.39 PER MONTH INSTALLED

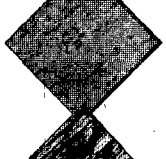

CORKTONE

With mellow, luxurious "real cork" look.

\$6.39 PER MONTH INSTALLED



"REGULAR"

Colorful as a peacock—in 18 lovely colors.

\$5.39 PER MONTH INSTALLED

You can't beat this value! Imagine... your own exclusive floor design in Kentile's lovely colors... expert installation backed by this famous guarantee. Time-saving, work-saving floor that resists stains and dirt that gleams like new with occasional waxing.



Guaranteed as Long as You Live in Your Home

Funds Available For Remodeling E-Z TERMS 36 MONTHS TO PAY

CARHART LUMBER COMPANY

Save on Floors

Save money when building the new home by using low-cost, utility grades of flat-grained hemlock or fir flooring where linoleum, asphalt tile, cork or wall-to-wall carpeting will cover the entire floor surface. You thus get all the advantages of resilient wood walking surfaces at lower cost.

Use Wayne Herald Want Ads



Headquarters for:

- ROOFING
- SIDING
- WIRING
- PAINTS
- INSULATION
- WATER HEATERS
- HEATING SYSTEMS
- COMPLETE SHALLOW AND DEEP WELL WATER SYSTEMS
- For Building and Remodeling Needs SEE



MAYTAG

SALES AND SERVICE

KUGLER ELECTRIC

106 Main Phone 322

Community Club Planning Two Christmas Activity Programs

Winside Community club voted Wednesday to sponsor Christmas programs at the local auditorium Dec. 17 and 24.

President Jean Boyd named G. E. Missett, Vernon Hill, Willis Reichert, Lewis Jenkins, John Gallop, C. E. Carlson and Stanley Hansen to the committee in charge.

Members also decided that Winside business firms would observe on the following holidays in 1956: New Year's, Memorial Day, July Fourth, Labor Day, Veterans' Day, Thanksgiving and Christmas.

A basketball tournament committee reported six teams will play in the annual invitational tournament in February. They are Belmont, Hoskins, Osmond, Randolph, Wayne Prep and Winside.

Letters of appreciation for the help given by the Winside Public School were read from second and third graders at Winside Public School.

Baptismal Dinner

Miss Hilbert was in charge of baptismal services at St. Paul Lutheran church Sunday.

Brian Lee, son of Mr. and Mrs. Russell Hoffman, and Elizabeth Arne, daughter of Mr. and Mrs. Byron Jaeger, were baptized.

Sponsors for the Hoffman infant were Mrs. Gus Frank, Hoskins, Bill Hoffman and Ervin Jaeger. Sponsors for the Jaeger girl were Jeannette Jaeger and Russell Hoffman.

The parents entertained at a dinner at the church before following morning services. Guests were Mr. and Mrs. Gus Frank, Hoskins, and Sandra, Hoskins, Mr. and Mrs. Gus Hoffman, Mr. and Mrs. Bill Hoffman, Mr. and Mrs. Gottlieb Jaeger and family, Mr. and Mrs. Herman Jaeger and wife, and Mrs. Hilbert and Rodney.

Move To Winside

Mr. and Mrs. R. B. Janke have moved into Winside Tuesday from their farm home south of town. Mr. and Mrs. Guy Stevon and family also moved to Winside Monday and will occupy the Elsie Horub residence in the northeast part of town.

Parent-Band

Winside Parent-Band association will meet Monday evening, Wayne Hasselquist, Norfolk band instructor, will be present. Hostesses will be Mr. and Mrs. Frank Prewitz and Supt. and Mrs. George Norris.

Mr. and Mrs. Robert Graef entertained Sunday evening to honor of Mrs. Graef's birthday. Cash prizes went to Mrs. Gus Hoffman, Carl Ehlers, Janet Graef, Edward Niemann and Ralph Andersen.

Busy Bee Project Club

Busy Bee Project club was entertained Thursday evening at the home of Mrs. Donald Quinn. Guests were Mrs. Charles Farran, Mrs. Chester Wylie and Mrs. Dale Hetrick, had charge of the business session. The club will hold its next dinner Dec. 22 at the home of Mrs. Joy Podoll. Mrs. Maurice Lindsay and Mrs. Duane Thompson had charge of the lesson on landscaping. Mrs. Wylie is a new member.

Missionary Society

Mrs. W. G. Volker, Wayne, was guest speaker at the meeting of Trinity Women's Missionary so-

ly, Wakefield, were Sunday afternoon visitors in the Jack Krueger home. Evening visitors were Mr. and Mrs. Bill Brogren and sons and Mr. and Mrs. Herbert Jaeger and family.

Mr. and Mrs. M. F. Weyerts and Mr. and Mrs. Dell Schütz, Norfolk, were visitors in the Otto Graef home Tuesday evening.

Mr. and Mrs. Gordon Hill, Oakland, spent the weekend in the Bill Wittie home, Chambers. They visited in the Otto Graef home enroute home Sunday.

Mr. and Mrs. Dean Alvin spent Thursday evening in the Ferdinand Voss home.

Society ...

Social Forecast

Friday, Nov. 25
Rebekah Lodge
Tuesday, Nov. 24
Contract Club
Wednesday, Nov. 30
Lignon Auxiliary

Central Circle Club

Central Circle Club was entertained Thursday afternoon at the home of Mrs. Bernice Bowers. Twelve members answered roll call.

Mrs. Wilfred Miller had charge of the business meeting. The club voted to contribute \$5 to a home at York for Christmas. A Christmas box was packed and sent to Harris Heinemann, San Diego, Calif. prizes went to Mrs. Louie Wilfong, Mrs. Harry Suchl, Mrs. Karl Benschoot, and Mrs. Otto Kant.

A Christmas party will be held Dec. 15 at the home of Mrs. Roy Davis. Gifts will be exchanged.

Modern Mrs. Club

Mrs. Frank Weible was hostess to Modern Mrs. club last Wednesday afternoon. Six members and one guest, Mrs. Leonard Andersen, were present.

Members discussed programs for 1956. Plans were discussed for a dinner and Christmas party at Norfolk Dec. 14. Mrs. Dale Smeal and Mrs. Garland Robbins will have charge of entertainment.

Three-Four's Club

Mrs. Gerald Hicks entertained the Three-Four's club Friday. Mrs. L. G. Gaebler was a guest at the bridge. Mrs. L. W. Kahl, Mrs. H. H. Hubert and Mrs. Gaebler received prizes. The club will meet Dec. 2 with Mrs. Hilbert.

Missionary Society

Members of Immanuel Women's Missionary society met at the Otto Kruenger home Nov. 19. Amelia Schroeder was hostess. Guests were Anna Bronzynski and Mrs. Steven Nettleton. Christine Luether was devotional leader and Mrs. William Fenske was program leader. Dec. 14 meeting will be at the church home for a go-nost dinner. Members of the congregation will be guests.

Funeral Services Held for Former Winside Farmer

Funeral services for Otto Kruenger, 79 former resident of the Winside community, were held last Wednesday at Norfolk. Mr. Kruenger died last Monday at a rest home in Newman Grove.

Burial was in Pleasant View cemetery, Winside. 11 years ago were Gilbert Westerkhaus, Leonard, Dale and Jack Krueger and Fredrick and Ervin Pfeiffer.

Otto Kruenger, son of Mr. and Mrs. Chris Kruenger, was born Jan. 9, 1876 in Germany. He came to Wayne county with his parents. He was confirmed in the Lutheran faith at Winside. In 1901 he moved to North Dakota, where he farmed until his return to Winside. He made his home in Winside until moving to Norfolk in 1950. He entered the rest home in 1952 because of failing health.

Survivors include: four sisters, Mrs. Henry Westerkhaus, Winside; Mrs. Jess DeWar, Whitefish, Mont.; Mrs. Arthur Heitbrink, Lincoln; and Mrs. Fred Pfeiffer, Hoskins, and two brothers, Frank and William, Norfolk.

Mrs. Wayne Long, Dennis and Billy, Norfolk, spent Monday with

Winside Community Club

Mrs. L. W. Kahl, Mrs. J. W. Missett, and Mrs. Fred Erickson, next meeting will be with Mrs. J. G. Sweigard.

Woman's Study Club

Woman's Study club met with Minnie Carstensen Friday afternoon. Mrs. W. J. Missett was a guest. Mrs. Anna Andersen conducted two contests. Mrs. Missett and Mrs. Sam Reichert won prizes.

Miss Carstensen, Mrs. Ferdinand Jensen and Mrs. Reichert drew gifts from the birthday basket. December meeting will be with Mrs. Reichert.

Scattered Neighbors

Mrs. Lester Deck and Mrs. Marvin Wittler were guests of Scattered Neighbors club last Wednesday afternoon at the home of Mrs. William Brogren. Mrs. Deck and Mrs. Wittler became members.

Mrs. Jack Krueger and Mrs. Warren Marotz had the lesson on landscaping. Mrs. Clarence Pfeiffer gave a book review. Members answered roll call with favorite cookie recipes.

St. Paul's Ev'nt. Lutheran Church

(H. M. Hilbert, pastor)
Saturday, Nov. 26: Church school, 1-3:15 p.m.
Sunday, Nov. 27: Early service, 9 a.m.; Sunday school, 10; late service, 10:45.

Trinity Lutheran Church

Sunday, Nov. 27: Sunday school, 10 a.m.; worship, 11; congregational meeting following morning service. Adult league.

Immanuel Reformed Church

(George Heusinger, pastor)
Sunday, Nov. 27: Worship, 9:30 a.m.; Sunday school, 10:30.

Supper guests in the George Koll home

Tuesday evening were Mr. and Mrs. Norman Deck and family, Mr. and Mrs. Herman Koll, Mrs. Mary Hieser, Anna and Emil Koll and Carl Nurnberg.

Mrs. Leonard Andersen, Carol, Bobbie and Betty were visitors in the Howard Deven home Sunday afternoon. The Elmer Nielsen family were also guests.

Supper evening visitors in the Harry Miller home

Mr. and Mrs. John Asmus, Carol and Lorna, Gay Miller and Mr. and Mrs. Ed Rathmann.

Mr. and Mrs. Edwin Brogren and daughters were Thursday evening visitors in the Ed Shellenberg home.

Bill Iversen entertained at a theme party Sunday afternoon

in honor of his birthday. Guests were Lloyd, Ramon, Norris Nielsen and Buford Prince.

Mr. and Mrs. Andrew Mann and family were Sunday evening visitors in the Wendell Ayets home, Norfolk.

Bertha, Minnie, Emma and George Koll were Sunday afternoon guests in the Herman Hilkemann, sr., home, Hadar, for Mrs. Hilkemann's birthday. Anna and Emil Koll were evening visitors.

Mr. and Mrs. Andrew Mann and family spent Sunday afternoon in the Fred Mann home.

Mr. and Mrs. Donald Wylie and daughter and Mr. and Mrs. John Rossaker, Norfolk, were Sunday afternoon guests in the Chester Wylie home.

Mr. and Mrs. Jack Krueger entertained Rev. C. H. Kemper, Fremont, at dinner Sunday noon. Rev. Kemper had charge of church services at Trinity church Sunday morning.

A group of relatives were entertained at the home of Mr. and Mrs. Ben Benschoot Thursday evening in honor of Mrs. Benschoot's birthday of Friday. Those present

WINSIDE NEWS

By Gladys Reichert, phone 2682

her parents, Mr. and Mrs. O. R. Selders.

Mr. and Mrs. Edgar Marotz and Carl Rohlf, Hoskins, were visitors in the Warren Marotz home Thursday evening.

Earl Selders, Norfolk, spent Saturday in the O. R. Selders home.

Mr. and Mrs. Donald Kay, Wakefield, were dinner guests in the Ferdinand Voss home Sunday.

Mr. and Mrs. Leo Voss were afternoon visitors.

Mr. and Mrs. Edgar Swanson and family were Sunday afternoon visitors in the Eldon Woods home, Carroll.

Mr. and Mrs. Warren Marotz and son spent Tuesday evening in the Adolf Miller home.

Mr. and Mrs. Don Hetrick and family, Osmond, were guests in the Dale Hetrick home Sunday.

Mr. and Mrs. Lyle Gamble, Wayne, spent Sunday evening in the Clarence Bronzynski home.

Mr. and Mrs. Howard Morris and family were Sunday evening visitors in the Wayne Imel home.

Mrs. Oakley Reed, Heartwell, arrived over the weekend to spend time with her son-in-law and daughter, Mr. and Mrs. Don Wacker and family.

Norma Floy Nielsen, Hoskins, was a visitor in the Howard Morris home Sunday afternoon.

Mrs. August Bronzynski and grandchildren and Anna Bronzynski were visitors in the Clarence Bronzynski home Sunday afternoon.

Mr. and Mrs. Fred Haines and family, Norfolk, were dinner guests in the Walter Spinden home.

Churches

Winside Methodist Church (C. L. VanMetre, pastor)
Sunday, Nov. 27: Sunday school, 10 a.m.; worship, "Another Side of The Alcohol Business," 11.

Churches

St. Paul's Ev'nt. Lutheran Church (H. M. Hilbert, pastor)
Saturday, Nov. 26: Church school, 1-3:15 p.m.
Sunday, Nov. 27: Early service, 9 a.m.; Sunday school, 10; late service, 10:45.

Churches

Trinity Lutheran Church
Sunday, Nov. 27: Sunday school, 10 a.m.; worship, 11; congregational meeting following morning service. Adult league.

Churches

Immanuel Reformed Church (George Heusinger, pastor)
Sunday, Nov. 27: Worship, 9:30 a.m.; Sunday school, 10:30.

Supper guests in the George Koll home Tuesday evening were Mr. and Mrs. Norman Deck and family, Mr. and Mrs. Herman Koll, Mrs. Mary Hieser, Anna and Emil Koll and Carl Nurnberg.

Mrs. Leonard Andersen, Carol, Bobbie and Betty were visitors in the Howard Deven home Sunday afternoon. The Elmer Nielsen family were also guests.

Supper evening visitors in the Harry Miller home were Mr. and Mrs. John Asmus, Carol and Lorna, Gay Miller and Mr. and Mrs. Ed Rathmann.

Mr. and Mrs. Edwin Brogren and daughters were Thursday evening visitors in the Ed Shellenberg home.

Bill Iversen entertained at a theme party Sunday afternoon in honor of his birthday. Guests were Lloyd, Ramon, Norris Nielsen and Buford Prince.

Mr. and Mrs. Andrew Mann and family were Sunday evening visitors in the Wendell Ayets home, Norfolk.

Bertha, Minnie, Emma and George Koll were Sunday afternoon guests in the Herman Hilkemann, sr., home, Hadar, for Mrs. Hilkemann's birthday. Anna and Emil Koll were evening visitors.

Mr. and Mrs. Andrew Mann and family spent Sunday afternoon in the Fred Mann home.

Mr. and Mrs. Donald Wylie and daughter and Mr. and Mrs. John Rossaker, Norfolk, were Sunday afternoon guests in the Chester Wylie home.

Mr. and Mrs. Jack Krueger entertained Rev. C. H. Kemper, Fremont, at dinner Sunday noon. Rev. Kemper had charge of church services at Trinity church Sunday morning.

A group of relatives were entertained at the home of Mr. and Mrs. Ben Benschoot Thursday evening in honor of Mrs. Benschoot's birthday of Friday. Those present

Mrs. Wayne Long, Dennis and Billy, Norfolk, spent Monday with

ENGLAND'S MOST POPULAR BREAD IS NOW AVAILABLE IN IOWA! ASK FOR HOVIS BREAD!

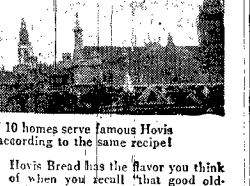

All over England, eight out of 10 homes serve famous Hovis Bread. Now it's baked here according to the same recipe!

Delicious Hovis Bread—famous among millions of delighted households for its fine flavor—is now here! You can buy it at your nearest food store starting today!

You'll love Hovis Bread for its pleasing taste—for the added pleasure it brings to every meal. And, as thousands of home-makers who have tried it, makes the best toast, sandwiches, canapés, goes wonderfully with butter and all spreads.

The secret of Hovis' popularity is in its appealing golden color and unusual vitamin content. Made from pure unbleached white flour, Hovis has added extra generous nourishment from the heart of the wheat. Tasty

Hovis Bread has the flavor you think of when you think of good old-fashioned bread we used to make at home. It gives you not only enjoyment but the extra energy we all need these busy days.

So ask for Hovis Bread—world-famous for more than 65 years—now available locally at all fine food stores!

were Mrs. James Mattison and Bridgett, Emerson, Mr. and Mrs. Harold Quind, Mr. and Mrs. Marie Benschoot and Wilbur, Mr. and Mrs. Otto Graef and family, Mr. and Mrs. William Loebach, and Mrs. John Loebach and Mr. and Mrs. Don Langenberg and Robert.

350 Attend Buffalo Supper Friday Night

An estimated 350 persons attended the annual Trinity Lutheran Brotherhood buffet supper Friday night at the auditorium.

Ladies in charge of the supper were Mrs. Edna Rasmussen, Mrs. Fred Wittler, Mrs. Martin Pfeiffer and Mrs. Chris Peterson. John Redel is Brotherhood president.

Special singing during the evening was furnished by Leonard Pritchard, Hoskins, Tom and Allen Pritchard, Norfolk, and Mrs. Cliff Swanson, Carroll. Mrs. Louie Johnson, Norfolk, played the accompaniment.

Mr. and Mrs. H. C. Hanson, Mr. and Mrs. Henry Andersen and Mr. and Mrs. Maurice Hanson and

Douglas, Carroll, were dinner guests Sunday in the Gurney Hanson home.

Mr. and Mrs. Edwin Brogren, Yvonne and Lois were Saturday evening visitors in the Ed Schradler home, Norfolk.

Sunday evening visitors in the Hazel Grimm home were Mr. and Mrs. Otto Koepke, Mr. and Mrs. Lester Koepke and family and Mrs. Edvin Brogren and family.

Mr. and Mrs. John Asmus were visitors in the Arnold "Boz" home Sunday afternoon.

Frank Steffen, Oakland, was a Sunday dinner guest of Willis Reichert at the Sam Reichert home.

Mr. and Mrs. Ed. Maas and Phyllis and Mr. and Mrs. Walter Fenske Hoskins, Mrs. Ferdinand Kahl and Mr. and Mrs. L. W. Kahl were guests at the Sam Reichert home last Tuesday evening in honor of Mrs. Reichert's birthday. Mr. and Mrs. August Spengler and Ruth, Norfolk, called during the evening. Mr. and Mrs. Edwin Strate and Deloris, Hoskins, were Monday evening guests at the Reichert home.

Mrs. Mary Weible was a Friday supper guest in the Andrew Mann home.

Mrs. William Rabe has returned to her home after spending a month with her son-in-law and daughter, Mr. and Mrs. William Price and family, Hayward, Calif. Mrs. Rabe also visited her brother-in-law and sister, Mr. and

Mrs. B. C. Rabe, Berthoud, Colo., and her sister-in-law, Mrs. Pauline Miller and Mrs. Louise Mueller, Denver.

Juniors Present Annual Drama

Winside high school juniors presented their annual play, "Finders Creepers," Friday night at the auditorium. A capacity crowd attended.

Principal Harry Torney directed the production. Cast members were Ramon Nielsen, Gary Kant, Karen Bowers, Marilyn Monk, Mary Craig, Georgiana Mann, Archie Lindsay, Helen Letting, Darrell Kremke, Dennis Hicks, Rose Ann Farran, George Carstensen, Ruth

Medlen and Bill Willers.

Other class members who participated were Nancy Prewitz, Jim Jenkins, Carolyn Benschoot, Patty Swan, Karen Jonson, Shirley Stevens, Buford Prince, Glenda Nelson, John Hamm, Bill Iversen and Lois Janke.

Darrell Kremke played two accordion solos during intermission.

Mr. and Mrs. W. F. Dangberg were dinner guests Sunday in the Charles Temme home, Wayne.

Mr. and Mrs. H. C. Hanson were Friday afternoon visitors in the Maurice Hanson home, Carroll.

Mr. and Mrs. Chester Wylie were Friday evening visitors in the P. C. Jensen home.

STRESS

Stress is what is left when glasses do not give proper co-ordination.

Be sure your child is not under stress while doing his school work.

Drs. Griffin & Griffin, Optometrists

300 Toy Bank Bldg., Sioux City Phone 5-9960
Office Hours: Weekdays 9-5; Saturday 9-12 noon

BEN FRANKLIN TOYTOWN OPENS TODAY!

- 2-Gun Holster: Two 10-in. cal. pistols, fancy leather holsters. **498**
- "Burr" Gun: Automatic! 2 1/2-in. long, 3 shots Kilgore caps. **398**
- Snare Drum: Metal 13-in. inch drum, 1 cloth and 1 parchment head. **98c**
- Tots' Toys: "Slinky" Dog: Plastic 10-in. dog with stretchy coiling middle. **198**
- Tiny Tot Carts: Peg and ball cart, whirling peg cart, many others! **98c**
- String-it Bead Set: 25 gay 1-1/8-in. beads, 2 3/8-in. plastic tip laces. **98c**
- Glamour Gifts: 60-Gauge Nylons: Lovely dark seams, 8 1/2, 3 prs., gift boxed, 2.77. **98c**
- Men's Socks: Argyle type! Cotton with nylon reinforced foot. **100**
- Simulated leather jewelry box **98c**
- Men's billfolds, embossed plastic **98c**
- 3-pc. towel set in floral print **198**
- Children's books, washable covers **25c**
- Checkers and other games to play **29c**
- *Plus F.E.T.

- 84-in. Track Big Train: **298** Set. Famous "Marx" model with 4 units, 28-3/4-in. long! Spring wind motor, bell.
- 17-in. Peggy Sits, Kneels! Flexible legs bend every way! Rooted hair, voice. **498**
- 15-in. Penny: She sleeps, cries, has legs that bend, kneel! **398**
- 15-in. Betsy Bow: She sleeps, cries, has long washable Sarah hair. **298**
- 13 1/2-in. Susan: Susan Stroller walks, sleeps, has rooted hair! **398**
- Miniature 8-in. Doll: Wearing gorgeous dress! Mohair wig, movable arms. **98c**
- Kiddie Jewelry: Necklace and matching coil bracelet in gay gift box. **29c** plus F.E.T.
- 8-Pc. Set TV Snack: Deep-cut crystal glass! 4 plates, 4 fitted cups. **149**
- Metal Airliner: 11 1/2-in. with friction motor, spinning propellers! **149**
- Dump Truck: Lever raises dump body, tail gate swings open. Steel 22-in. model. **298**
- Steam Shovel: Steel 20-3/4-in. "Tonka" model! Rotating cab, ratchet crank. **298**
- Doll House Furniture: Miniature plastic furnishings for 6 full rooms! Per room **149**
- Embroidery Set: 5 stamped art pieces, hoops, needle, scissors, thread! **98c**
- Foil Gift Wrapping: Glittering silver foil 2 1/2 big sheets, 20x26-in. **25c**
- Tree Ornaments: Box of 12 assorted 2-in. to 3 1/2-in. sizes. **89c - 1.29**
- Christmas tree stand **79c**
- 15-in. Holly wreath **1.59**
- Tags, seals, cards **10c** up
- Gift-wrap ribbons **10c** up

BEN FRANKLIN
LOCALLY OWNED - NATIONALLY KNOWN

WE WILL BE OPEN NIGHTS UNTIL 9:30 ON DATES SHOWN IN BLACK ON THE CALENDAR

KIDS Ask for Free Train Ride Tickets at Our Store

"Pitcher of health"



You and your family will feel better and live better with Quality Chekd Homogenized Milk. When you drink Quality Chekd Milk you reduce calcium deficiencies... ease nervous tension... sleep better... feel healthier

Patterson

Quality Chekd HOMOGENIZED MILK

BUY THE PACKAGE WITH THE BIG RED CHECK

All over England, eight out of 10 homes serve famous Hovis Bread. Now it's baked here according to the same recipe!

Delicious Hovis Bread—famous among millions of delighted households for its fine flavor—is now here! You can buy it at your nearest food store starting today!

You'll love Hovis Bread for its pleasing taste—for the added pleasure it brings to every meal. And, as thousands of home-makers who have tried it, makes the best toast, sandwiches, canapés, goes wonderfully with butter and all spreads.

The secret of Hovis' popularity is in its appealing golden color and unusual vitamin content. Made from pure unbleached white flour, Hovis has added extra generous nourishment from the heart of the wheat. Tasty

Hovis Bread has the flavor you think of when you think of good old-fashioned bread we used to make at home. It gives you not only enjoyment but the extra energy we all need these busy days.

So ask for Hovis Bread—world-famous for more than 65 years—now available locally at all fine food stores!

CARROLL

Mrs. Dale Smeal Elected as New Catholic Guild President

Mrs. Dale Smeal was elected president at Catholic Guild meeting Wednesday afternoon. Other officers named were: Mrs. James Kavanagh, vice president; Mrs. Ole Anderson, secretary-treasurer; and Mrs. Paul Schrad, social leader.

A Christmas party is planned with covered dish luncheon and gift exchange. Mrs. Harry Nelson and Mrs. Lee Collins were hostesses Wednesday.

Receives Award Kurt and Carla Rethwisch, Bill and Dick Gries, Jim Sloan and Donald Leitman, all members of the Blue Ribbon Sewers 4-H club, and their families attended 4-H achievement meeting at Wayne last Tuesday evening. Kurt was awarded club week trip for dairy showmanship.

Book Week Display Mrs. Russell Moprieth and District 84 pupils arranged a window scene for F & M Market this week. The theme is in keeping with "National Book Week" and features a "Story Land Castle" with children standing before it. The children are dolls dressed to represent some story book character.

Enlist in Navy Roger Claussen, son of Mrs. Elsie Claussen and Gary Lee Swartz, son of Mr. and Mrs. Glen Swartz, Pierce, enlisted in the Navy and went to Omaha Monday for their physicals. They expected to be assigned to the San Francisco Naval Base. A party for both boys was held Sunday evening in the Claussen home.

Mrs. Nettleton Dies Forrest and Steve Nettleton received word Sunday of the death of their mother, Mrs. Harry Nettleton, Bakersfield, Calif. Funeral arrangements are not completed. The body will be brought to Norfolk for services.

Baptismal Dinner Relatives were guests for dinner Sunday in the home of Mr. and Mrs. Clarence Grandquist in honor of the baptism of their daughter, Carla Gail. Those present were

Mrs. W. R. French and Darrell, Mr. and Mrs. John Hanson and family, Mr. and Mrs. Raymond Otte and family and Mr. and Mrs. Lynn Roberts and sons.

School Closed Public school will be closed Thursday and Friday for Thanksgiving vacation.

Undergoes Surgery Everett Walker underwent surgery for hernia Monday morning in the Methodist hospital, Sioux City. Mrs. Waller is there with her husband. Steven is staying in the Roland Stahl home. Mr. and Mrs. Norval Waller are doing chores at the Waller home.

Farewell Party Mr. and Mrs. Glen Hall and family, who are moving to Washington state soon, were honored at a party Sunday evening in the Lutheran church parlors. Cards furnished entertainment. Ladies Aid presented Mrs. Hall a gift. Mrs. Hall was president of the local group the past year. LLL sponsored the party. About 50 guests attended. Cooperative lunch was served.

Society

Social Forecast Friday, Nov. 25 Westminster Guild Tuesday, Nov. 29 Way-Out-Here, Mrs. Irene Alderson and Mrs. Nola Jones Wednesday, Nov. 30 WSCS Pinochle Club, Mr. and Mrs. Russell Hall Thursday, Dec. 1 EOT, Mrs. Martin Rashussen

WSCS "Through Our Missionaries," the second lesson of the study course was given for WSCS meeting Wednesday afternoon. Mrs. Ed Shufelt assisted by Mrs. C. A. Beaton and Mrs. Jay Tucker, led devotions. Mrs. Worley Benshoof and Mrs. Keith Reed were in charge of a skit. Mrs. Charles

Whitney discussed work of missionaries that attended mission school at Lincoln in August. Six Junior choir members sang a number with Mrs. Whitney at the piano. Mrs. Earl Davis served. Mrs. C. L. VanMetre will be hostess for the next meeting. Mrs. Gust Johnson will be devotional leader.

Hillcrest Mrs. Irve Jones and Mrs. Frank Vlasak were hostesses for Hillcrest Tuesday afternoon at the Jones home. Fifteen members were present. Guest was Mrs. Russell Beckman. Landscaping lesson was given by Mrs. Harry Gries and Mrs. Leo Jordan. Mrs. J. P. Roberts read an article. Mrs. Joe Hinkle, Mrs. Lloyd Dunklau and Mrs. Irve Jones gave a report of a visit made to Norfolk Opportunity center. Christmas offering will be used to provide a gift for each child enrolled at the center. There will be a gift exchange and secret sisters will be revealed at the Christmas meeting, Dec. 6 at the home of Mrs. G. E. Jones.

Friendly Wednesday Mrs. Julius Menke and Mrs. Lester Menke were guests of Friendly Wednesday club at the home of Mrs. Alfred Seivers Wednesday afternoon. Mrs. Harry Beckner was in charge of games. Christmas meeting will be with Mrs. Otto Kock.

GST Mr. and Mrs. Ardale Test, Wayne, were guests of GST Friday evening at the home of Mr. and Mrs. Wayne Kerstine. Prizes in cards were received by Mrs. John Paulsen, Mrs. Irve Morris, Bob Johnson and Stanley Morris. Mr. and Mrs. Merlin Kenny are hosts for the next meeting.

Knitting Club Twelve members and one guest, Mrs. F. R. Clark, attended Knitting club Friday afternoon at the home of Mrs. D. E. Jones. Christesses are Mrs. L. E. Jenkins and Lois and Mrs. George Owens.

Country Card Club Mr. and Mrs. Bob Peterson were hosts Friday evening for the Country Card club. Prizes were received by Ed Fork, George Johnston, Elmer Jones, Mrs. August Franzon and Mrs. Don Davis. Dec. 2 meeting will be with Mr. and Mrs. Fork.

EOT November card party for EOT was held Friday evening in the home of Mr. and Mrs. Gilmore Sabu. Mr. and Mrs. Gene Sandahl were assistant hosts. Mr. and Mrs. Allen Perdue were guests. Evening prizes went to Mr. and Mrs. Ray Finn, Mrs. George Seiger, Ray Hanson, Mrs. Harry Hofeldt and

weeks will be with Mr. and Mrs. E. C. Phillips.

Social Neighbors Roll call for Social Neighbors meeting Thursday afternoon at the home of Mrs. George Bodenstedt was "A Gift I Appreciated Most." Prizes in cards went to Mrs. Harold Stoltenberg and Mrs. John Rudbusch. The club Christmas party will be Dec. 8 with Mrs. Kenneth Eddie, Dec. 3 evening party will be at the home of Mr. and Mrs. Vernon Hokamp. Mr. and Mrs. Bob Bodenstedt are new members of the evening group.

Pinochle Club Four tables of cards were played Wednesday evening at the home of Mr. and Mrs. Harry Gries. Honors were held by Mr. and Mrs. Russell Hall, Mrs. Harry Nelson and Howard Loeb. Nov. 30 meeting will be at the Russell Hall home.

Delta Dek Delta Dek had two parties during the week. Monday evening husbands were guests at the home of Mr. and Mrs. Perry Johnson. Mrs. G. E. Jones and Mrs. Charles Whitney assisted as hostesses. Mrs. Arthur Glass, Mrs. Clair Swanson and Mrs. Knoll Roll call for the next meeting is a proverb. Family Christmas party will be at the home of Mr. and Mrs. John Davis Dec. 15.

Happy Workers Mrs. Adolph Rohlf was hostess for seven members of Happy Workers and three guests at her home Thursday afternoon. Guests were Mrs. Gustav Koll, Mrs. William Knoll and Mrs. Chris Franz. Card prizes were received by Mrs. Arthur Glass, Mrs. Clair Swanson and Mrs. Knoll. Roll call for the next meeting is a proverb. Family Christmas party will be at the home of Mr. and Mrs. John Davis Dec. 15.

Churches St. Paul's Lutheran Church (Roy Beckmann, pastor) Thursday, Nov. 24: Thanksgiving service, 10 a.m. Sunday, Nov. 27: Sunday school, 10 a.m.; worship, 10:45. Carroll Methodist Church (C. L. VanMetre, pastor) Sunday, Nov. 27: Worship, "Another Side of The Alcohol Business," 9:45 a.m.; Sunday school, 10:45. Wednesday, Nov. 30: WSCS. Mr. and Mrs. Lawrence Johnson, Wakefield, and Mr. and Mrs. Clarence Johnson and family were Sunday afternoon callers in the home of Mr. and Mrs. Bob Johnson.

Mr. and Mrs. Norval Waller came to the home of Mr. and Mrs. Robert Waller Saturday night from Aberdeen, Md., where Mr. Waller received his discharge after two years' Army service. The couple plan to engage in farming operations and will move by spring to the farm where Mr. and Mrs. Ed Fork now live.

Mrs. Roland Stahl entertained 12 children at a party Sunday afternoon for Rolene's third birthday. Mr. and Mrs. Robert Waller, Mr. and Mrs. Norval Waller and Mr. and Mrs. Everett Waller and

CARROLL NEWS

By Mrs. Fred Baird-Phone 1 on 19

Mr. and Mrs. Virgil Shufelt and Duane and Mr. and Mrs. Bill Wippenling and John spent Saturday evening in the Bill Shufelt home. Mr. and Mrs. R. E. Jones were there Thursday evening. Mr. and Mrs. Fred Eckert and family and Mr. and Mrs. Dee Rasmussen and family were guests for dinner Wednesday evening in the home of Mr. and Mrs. Don Painter for Beverly's birthday.

St. Paul's Lutheran Church (Roy Beckmann, pastor) Thursday, Nov. 24: Thanksgiving service, 10 a.m. Sunday, Nov. 27: Sunday school, 10 a.m.; worship, 10:45.

Carroll Methodist Church (C. L. VanMetre, pastor) Sunday, Nov. 27: Worship, "Another Side of The Alcohol Business," 9:45 a.m.; Sunday school, 10:45. Wednesday, Nov. 30: WSCS.

Mr. and Mrs. Lawrence Johnson, Wakefield, and Mr. and Mrs. Clarence Johnson and family were Sunday afternoon callers in the home of Mr. and Mrs. Bob Johnson.

Mr. and Mrs. Norval Waller came to the home of Mr. and Mrs. Robert Waller Saturday night from Aberdeen, Md., where Mr. Waller received his discharge after two years' Army service. The couple plan to engage in farming operations and will move by spring to the farm where Mr. and Mrs. Ed Fork now live.

Mrs. Roland Stahl entertained 12 children at a party Sunday afternoon for Rolene's third birthday. Mr. and Mrs. Robert Waller, Mr. and Mrs. Norval Waller and Mr. and Mrs. Everett Waller and

Eleven were guests in the Stahl home for dinner for the same occasion. Connie Rethwisch observed her twelfth birthday Saturday when she and three friends went roller skating in Wayne. Her guests were Cheryl Jenkins, Sally Wagner and Cathy Longerson. Cheryl stayed overnight in the Rethwisch home. Mrs. Glen Frink and daughters were guests of Mr. and Mrs. Walter Rethwisch for supper Sunday. Mr. and Mrs. Rethwisch spent the afternoon in the Merton Jones home.

Mrs. Henry Anderson, who was very ill, was taken to Lutheran hospital, Norfolk, Sunday night. Cause of her illness was undetermined at this writing. Mrs. Alfred Thomas went to Salida, Colo. to attend the wedding Sunday of her brother, Darwin Jones.

Mr. and Mrs. Harry Gries and family and the Merlin Kenny children spent Friday evening in the home of Mr. and Mrs. J. C. Woods for Mrs. Woods' birthday.

LEGAL NOTICES

LEGAL PROCEEDINGS

Village Board Proceedings Carroll, Neb., Nov. 18, 1955, 7:30 p.m. The Board of Trustees of the Village of Carroll met in special meeting on the above date and time for hearing on the liquor application of Joe F. Peterson with the following members present: Claude Bailey, J. A. Peterson, Maurice Hanson, Perry Johnson and absentees: Mrs. J. A. Peterson. The application of Joe F. Peterson for a Retail Beer in Corporate Limits, On Sale and Off Sale License was read. It was moved by Perry Johnson and seconded by E. L. Pearson that the license be granted subject to the approval of the Nebraska Liquor Control Commission. Motion carried unanimously. There being no further business, the meeting adjourned. Approved: Claude Bailey, Chairman of the Board. Signed: David C. Garwood, Village Clerk

So & Sew Officers Elected Here Thursday So & Sew club met at the home of Mrs. Martha Spader Thursday afternoon. Officers elected were: president, Mrs. Lars Olson; vice president, Mrs. Joe Hinkle; secretary-treasurer, Mrs. Walt Gubbels; news reporter, Mrs. Vincent Wilhelm; and poets, Mrs. Lloyd Dunklin. The Christmas party will be a noon luncheon Dec. 8, with husbands as guests at the Olson home.

Mrs. Janice Stejskal and District 75 pupils had a hot dinner at the school house Friday as a farewell for Colleen Hall, who is moving with her parents from the community. Mr. and Mrs. Bill Thomas, Ambury, Kan., returned to their home Wednesday after spending a week with their daughter, Mrs. Don Davis, and family. Other guests Sunday in the Davis home included Mr. and Mrs. Earl Davis and Mr. and Mrs. Gordon Davis and Candice. The latter two families spent the evening in the Mrs. Emma Davis home.

Mr. and Mrs. Erwin Withler spent Saturday with Mr. and Mrs. William Withler, Coleridge. Mr. and Mrs. Lyle Bremer and Mrs. Abigail Thomas, Columbus, and Mr. and Mrs. Larry Snyder, Omaha, were guests of Mrs. Emma Davis and Everett for dinner Sunday for the birthdays of Mr. Ed Johnson and Mrs. Snyder. During the afternoon Mrs. Thomas and Mrs. Davis visited Mrs. E. O. Davis. Rees Richards, Norfolk, was also a caller in the Mrs. Emma Davis home.

Mr. and Mrs. Bob Johnson and family visited Mr. and Mrs. Luck Tucker, Sioux City, Saturday. Ernest and Gladys Fork and dinner Sunday with Mr. and Mrs. Ed Fork and family for Lonnie's ninth birthday. Mr. and Mrs. Ray Hammer were Sunday visitors in the E. M. Morris home, Wayne. Mrs. Walter Sloan spent Thursday with her daughter, Mrs. Elwin Nitz, Randolph. More CARROLL—page 5

For '56 Plenty of EXTRA in this SPECIAL

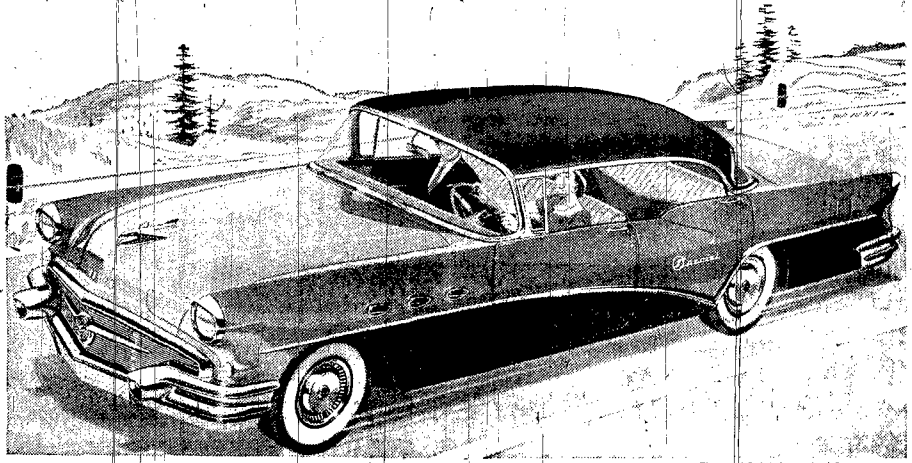

The 1956 Buick SPECIAL 4-Door Riviera

This one is the news-maker that's front-page big. This one is the new Buick SPECIAL for 1956—the biggest bundle of high-powered energy and high-fashion luxury ever offered in Buick's lowest-priced Series. Just a quick listing of some certain facts will give you the picture. First—its engine is a big new 322-cubic-inch V8 engine with an all-time high in horsepower for this Series—and an engine that hits the record book at a neat 8.9 to 1 compression ratio. Second—its getaway—with the double-action take-off of the new Variable Pitch Dynaflo—is spectacular even at only part throttle—and comes with a new boost in gas mileage to boot. Third—on ride, this new SPECIAL is more than great—what with all-coil springing, and torque-tube stability, and a new deep-oil cushioning, and a whole new front-end geometry that adds a wonderful "sense of direction" to the car's travel. Fourth—on room, luxury, interior finish—there's never been a Buick SPECIAL like this before. From the big, broad seats to the stunning new instrument panel—there's new decorator smartness and quality throughout.

But get the picture on price, and you have the biggest reason why this sizable automobile is so extra special a buy. For this Buick comes to you at a figure so close to those of the most widely known smaller cars, the difference in price is small change. So—come in and see and sample this beauty. You'll find it, we firmly believe, the biggest package of automobile at anywhere near its budget price.

*New Advanced Variable Pitch Dynaflo is the only Dynaflo Buick builds today. It is standard on Roadmaster, Super and Century—optional at modest extra cost on the Special.

Best Buick yet SEE JACKIE GLEASON ON TV Every Saturday Evening Get 4-Season Comfort in your new Buick with FRIGIDAIRE CONDITIONING—now at a new low price.

ATTEND THE GRAND OPENING of Sew-Vac Co. in Wayne 307 MAIN FORMER RUSSELL'S GROCERY LOCATION FRIDAY-SATURDAY, Nov. 25-26



Pick a Prize—EVERYONE WINS! ADLER Gift Bowl! \$10,000 worth of gifts 1st prize—new cabinet model sewing machine 2nd prize—automatic pop-up toaster 3rd prize—automatic coffee maker Hundreds of other prizes! Absolutely free! Just come in and pick your prize slip from the ADLER Gift Bowl. You can't lose. Everyone wins a free gift... and you may be the lucky grand prize winner of a brand new cabinet model sewing machine. Come in today! LADIES ONLY

When You Come In, Be Sure To See The ADLER AUTOMATIC Automatically you can embroider hundreds and hundreds of beautiful patterns. Automatically you can blindstitch hems and sew in linings. Automatically you'll save hours and hours of handsewing time. And, you'll be able to do all home sewing jobs without attachments. MOST ADVANCED • MOST AUTOMATIC Authorized FILTER QUEEN Home Sanitation Dealer We have the Finest in Sewing Machines and Home Sanitation Units STOP IN FOR A DEMONSTRATION We Service All Makes and Models of Sewing Machines and Vacuums Dick Boyce, owner

HERB'S BUICK COMPANY

New Officers Elected Monday At Dixon Farm Bureau Meet

Dixon Farm Bureau met at Dixon high school auditorium last Monday night. New officers were elected.

Named to offices were: Oliver Noe, president; Gerald Jewell, vice president; Russell Nissen, secretary; treasurer; Mrs. Jewell, women's chairman; Ralph Noe, Clark township delegate, and Art Johnson, Concord township delegate.

Members voted to send two delegates to the National convention in Chicago Dec. 12. Mrs. Jewell led a study of national, state and county officers. It will be continued at the next meeting Dec. 12. Lunch was served by Mr. and Mrs. Roy Pearson and Mr. and Mrs. George Luetje.

Irish Open Season
Dixon's Fighting Irish opened their basketball season Friday evening losing to Randolph St. Francis 56-29. The second team lost 55-27.

Adopt Daughter
Mr. and Mrs. Dale Davidson have adopted a six-month-old girl. They have named her Ann Melinda. Guests Thursday and Friday in the Davidson home were Mrs. Betty Garvin, Mrs. Jean Minee, Mr. and Mrs. Marion Gust and family, Mr. and Mrs. Walter Peterson and family, Mr. and Mrs. Rex Troth and boys, Mr. and Mrs. Gerald Jewell and family and Mr. and Mrs. Eldred Smith.

Breaks Arm in Fall
Darwyn Peterson, son of Mr. and Mrs. Walter Peterson, fell from the roof of a corn crib Sunday afternoon on the Gerald Jewell farm. Darwyn suffered a broken arm and spent Sunday evening in the Bentback hospital.

Mr. and Mrs. Fred Walters were visitors Tuesday in the Andrew Johnson home, Wayne. Mr. and Mrs. Donald Peters were Monday evening guests in the Peter Peters home, Sioux City. Mr. and Mrs. Earl Eckert were Thursday evening guests in the Donald Peters home.

Mrs. Ralph Peterson and family and Mrs. Harrison were guests Tuesday evening in the Vernon Bass home. Monday dinner guests of Mr. and Mrs. Vernon Bass were Mr. and Mrs. Raymond Malcom, Janice and Rog. e. Sunday supper guests in the Donald Peters home were Mr.

DIXON NEWS

Mrs. Earl Ankeny, Phone 121R19
(Continued from page 3)

Mrs. Lawrence Smith and Mark Wayne, and Mr. and Mrs. George Eickhoff, Wakefield.

Mrs. A. P. Borg attended a supper last Monday evening in Allen honoring Mrs. Lois Clifton, who is moving from that community to Omaha.

Last Monday guests in the Newell Stanley home were Mr. and Mrs. Claude Stanley and Mr. and Mrs. Gerald Stanley and children.

Mr. and Mrs. John Young brought their daughter, Brenda, home from Immanuel hospital, Omaha, Thursday.

Society ...
Missionary Society
Women's Foreign Missionary society of the Nazarene church held an all day meeting in the home of Mrs. Martin Koch Thursday. The day was spent sewing for the missionary family the group helps support.

Coffee Club
Coffee club met Friday in the home of Rose Garvin. Eight members were present. Next meeting will be held with Mrs. Nora Bose.

MYF Play
Methodist MYF are planning to present a play during the Christmas season. The play chosen is "Good Will Toward Women."

Victory 4-H
Victory 4-H met at the Hans Johnson home Nov. 9. Larry Berg and Ronnie McCaw joined. Next meeting will be held at the Ernie Knoell home Dec. 14.

Mrs. Alice Macklin is reported in poor condition at the home of her son, Guy Macklin, South Sioux City at this writing. Mrs. Macklin suffered another stroke last week. Donna Goodman was a Friday evening guest in the Earl Peterson home.

Marvin Nelson, Dotna Goodman and Mary Ann Peterson took Tom Park to Omaha Friday morning.

Park left by train for the East Coast from where he will go overseas.

Mary Ann Peterson was a weekend guest of Dotna Goodman, Tekamah.

Mr. and Mrs. Ipsie Park and Susie, Norfolk, were Friday evening guests in the Elmer Sundell home, Allen.

Mr. and Mrs. Tony Math, Oberlin, were last Sunday visitors in the Oliver Noe home.

Mr. and Mrs. Oliver Noe and Darlene were Sunday afternoon visitors at the Mrs. Emma Noe home, Allen.

Mr. and Mrs. Patterson and Patricia, Omaha, and Mr. and Mrs. Lloyd Wendall and Dick were last Sunday dinner guests in the Raymond Spaly home.

Mr. and Mrs. Glenn Noe went to Spencer, Ia., last Sunday to visit Mrs. Noe's sister, Mrs. Jim Hault and family.

Mr. and Mrs. Clifford Schultz and Johnny visited their parents in Minong, Minn. last Sunday.

Churches ...

Dixon Methodist Church
(Harold Bonah, pastor)
Sunday, Nov. 27: Sunday school, 10 a. m.; worship, "Why the Church?", 11.
Wednesday, Nov. 30: Prayer service, 8 p. m.
Thursday, Dec. 1: MYF, 8:15 p. m.

Rose Hill Nazarene Church
(Clifford Schultz, pastor)
Sunday, Nov. 27: Sunday school, 10 a. m.; worship, 11.
Wednesday, Nov. 30: Prayer service, 8 p. m.
Thursday, Dec. 1: WFMF.

St. Anne's Catholic Church
(Clement Bracht, pastor)
Sunday, Nov. 27: Mass, 8 a. m.

Mr. and Mrs. Clarence Henningsen went to Fremont Friday. They attended an opera presented by the schools. Their daughter, Carroll, who teaches in Fremont, re-

Carroll

By Mrs. Fred Baird
Phone 1 on 19
(Continued from page 4)

Mr. and Mrs. Dick Chambers were Sunday afternoon guests in the Clarence Minor home, Laurel. Mrs. Bessie Davidson, Wayne, and Grace Davidson, Cherokee, Ia., were Sunday dinner guests in the Dale Davidson home.

Friday Mr. and Mrs. Donald Peters, Donna Kay and Mary Jane had dinner in the George Eickhoff home, Wakefield. That evening they visited in the William Lippitt home, Allen.

Mrs. Don Peters and Donna Kay called in the Frank Henschke home Friday afternoon to make the acquaintance of the new baby of Mr. and Mrs. Eldor Henschke.

Guests in the John Young home Sunday in honor of Mrs. Young's birthday were Mr. and Mrs. Alfred Jensen, Mr. and Mrs. Shine Jensen and family, Mr. and Mrs. Verlin Jensen and family, Mr. and Mrs. Marvin Jensen and family, Laurel, Mr. and Mrs. Vernon Jensen, Oberlin, Wayne, Wakefield, and Mrs. Violet Johnson.

Guests Friday evening in the John Young home were Mr. and Mrs. Paul Thomas and daughters. Mr. and Mrs. Clarence McCaw were dinner guests Thursday at the Jim McCaw home.

Mrs. Irma Kraemer and Dianne spent Sunday afternoon in Colorado visiting friends and relatives. Sharon Prescott and Jeanette Lamb were Saturday night guests of Dianne Kraemer.

Mrs. John Swallow and Steve, Loggie, Lynda and Leta Saunders were Sunday afternoon guests in the Irma Kraemer home.

Douglas Payne is staying with his grandparents, Mr. and Mrs. Merrill Jewell.

Mr. and Mrs. John Schooner, Sioux City, visited in the Merrill Jewell home Sunday.

Mrs. Mary Dougherty was a Monday afternoon caller in the Margaret Dougherty home.

Mr. and Mrs. Arthur Fegley were Sunday dinner guests of Mr. and Mrs. Clarence Wilson, Allen. Mrs. Martin Kock and Connie spent the weekend with relatives in Sioux City.

Mr. and Mrs. Henry McCaw spent the weekend in Omaha with relatives. They attended Mrs. McCaw's sister's wedding.

Margaret Kavanagh was a weekend visitor in the Paul Tunink home, Randolph.

Mr. and Mrs. Stanley Morris and family and Mr. and Mrs. T. C. Winterstein drove to Emerson Sunday to spend the day in the Glenwood Black home.

N. F. Morris, Genoa, came Thursday to visit his brothers C. H. and Lot Morris.

Mr. and Mrs. Fredrick Niemann and Gay Renee spent Thursday evening in the Stanley Hansen home.

Carroll

By Mrs. Fred Baird
Phone 1 on 19
(Continued from page 4)

Mr. and Mrs. Worley Benshoof and Kermit are Thanksgiving guests in the home of Mr. and Mrs. Alvan Marshall, Norfolk.

Marlis Williams was a Monday overnight and Colleen Half a Friday overnight guest of Lois Stoltenberg.

Mr. and Mrs. Earl Anderson and Mr. and Mrs. Vernon Hokamp attended the Colorado-Nebraska football game Nov. 12. Peggy and Pamela Hokamp spent the day in the Bob Johnson home.

Mr. and Mrs. Harry Gries and family were Saturday visitors in the E. E. Ankeny home for Mrs. Ankeny's birthday.

Mr. and Mrs. Dale Claussen and family moved during the past week to the farm recently vacated by Mr. and Mrs. Martin Rasmussen.

Mrs. Lena Texley came home from Lincoln Tuesday to spend Thanksgiving vacation in the Lloyd Texley home.

Mrs. Cora Texley, Lloyd and Laurence were Omaha visitors Tuesday.

Mr. and Mrs. Warren Jacobson and family were Sunday visitors in the Stanley Hansen home, Mr. and Mrs. Hansen called Friday evening in the home of Mr. and Mrs. Stanley Soden, near Winside.

Mr. and Mrs. Melvin Magnuson and family had dinner Sunday with Mrs. C. J. Magnuson. They called Friday evening in the Virgil Pearson home.

Mr. and Mrs. Gust Johnson entertained at cards Saturday evening in honor of Mrs. Johnson's birthday. Guests included Mr. and Mrs. Anton Peterson, Mr. and Mrs. M. W. Ahern, Mr. and Mrs. Herman Brockman, Mr. and Mrs. Grover Bass, Mr. and Mrs. Martin Paulsen, and Angela, Mr. and Mrs. Art Lage, Mrs. Emma Davis and Elmer Haberman.

Mrs. Ann Hughes is somewhat improved after a light stroke Tuesday night. Visitors who called in the Mrs. Sylvia Jones home included Mr. and Mrs. Dave Rees, Mr. and Mrs. R. E. Jones, Mr. and Mrs. Marvin Glass and family, Mr. and Mrs. Tom Hughes and Mr. and Mrs. Glen Jones and sons. The latter family have moved here from Montrose, S. D. and will live on a farm north of Hoskins as soon as the place is vacated.

Mr. and Mrs. Martin Rasmussen and Mr. and Mrs. Raymond Hanson and family joined the Gerhard Herbolzheimer family, Wakefield, Sunday for pre-Thanksgiving dinner in the Herbolzheimer home.

Mr. and Mrs. Hollis Williams and Marlis had Wednesday evening dinner in the Gerhard Wacker home.

Mr. and Mrs. Art Grone and Karen were Thursday afternoon visitors in the Lloyd Texley home.

Mr. and Mrs. Peter Peterson, Wayne, were guests for dinner Tuesday evening in the home of Mr. and Mrs. Perry Johnson. Mr. Peterson, uncle of Mrs. Johnson, returned a week ago after completing a government project in Iceland. He also made a visit to Denmark.

Mrs. Vernon Hansen and Kirk, Neligh, spent this week with her parents, Mr. and Mrs. Wesley Rubek.

Carroll

By Mrs. Fred Baird
Phone 1 on 19
(Continued from page 4)

Mr. and Mrs. Earl Anderson and Mr. and Mrs. Vernon Hokamp attended the Colorado-Nebraska football game Nov. 12. Peggy and Pamela Hokamp spent the day in the Bob Johnson home.

Mr. and Mrs. Harry Gries and family were Saturday visitors in the E. E. Ankeny home for Mrs. Ankeny's birthday.

Mr. and Mrs. Dale Claussen and family moved during the past week to the farm recently vacated by Mr. and Mrs. Martin Rasmussen.

Mrs. Lena Texley came home from Lincoln Tuesday to spend Thanksgiving vacation in the Lloyd Texley home.

Mrs. Cora Texley, Lloyd and Laurence were Omaha visitors Tuesday.

Mr. and Mrs. Warren Jacobson and family were Sunday visitors in the Stanley Hansen home, Mr. and Mrs. Hansen called Friday evening in the home of Mr. and Mrs. Stanley Soden, near Winside.

Mr. and Mrs. Melvin Magnuson and family had dinner Sunday with Mrs. C. J. Magnuson. They called Friday evening in the Virgil Pearson home.

Mr. and Mrs. Gust Johnson entertained at cards Saturday evening in honor of Mrs. Johnson's birthday. Guests included Mr. and Mrs. Anton Peterson, Mr. and Mrs. M. W. Ahern, Mr. and Mrs. Herman Brockman, Mr. and Mrs. Grover Bass, Mr. and Mrs. Martin Paulsen, and Angela, Mr. and Mrs. Art Lage, Mrs. Emma Davis and Elmer Haberman.

Mrs. Ann Hughes is somewhat improved after a light stroke Tuesday night. Visitors who called in the Mrs. Sylvia Jones home included Mr. and Mrs. Dave Rees, Mr. and Mrs. R. E. Jones, Mr. and Mrs. Marvin Glass and family, Mr. and Mrs. Tom Hughes and Mr. and Mrs. Glen Jones and sons. The latter family have moved here from Montrose, S. D. and will live on a farm north of Hoskins as soon as the place is vacated.

Mr. and Mrs. Martin Rasmussen and Mr. and Mrs. Raymond Hanson and family joined the Gerhard Herbolzheimer family, Wakefield, Sunday for pre-Thanksgiving dinner in the Herbolzheimer home.

Mr. and Mrs. Hollis Williams and Marlis had Wednesday evening dinner in the Gerhard Wacker home.

Mr. and Mrs. Art Grone and Karen were Thursday afternoon visitors in the Lloyd Texley home.

Mr. and Mrs. Peter Peterson, Wayne, were guests for dinner Tuesday evening in the home of Mr. and Mrs. Perry Johnson. Mr. Peterson, uncle of Mrs. Johnson, returned a week ago after completing a government project in Iceland. He also made a visit to Denmark.

Mrs. Vernon Hansen and Kirk, Neligh, spent this week with her parents, Mr. and Mrs. Wesley Rubek.

Mr. and Mrs. Kenny Wimmer and family, Lincoln. Mr. and Mrs. Howard Loeb and Bob and Mrs. David Stejskal were among guests for dinner Sunday in the Clifford Menke home, Yankton. Menkes are cousins of Mr. Loeb. Mr. and Mrs. LeVine Harder and family spent Friday evening in the Nels Granquist home. Mrs. O. B. Morris, Randolph, had dinner Monday with Mr. and Mrs. John Davis. Lot Morris was there for dinner Thursday. Mr. and Mrs. E. C. Woods were Thursday evening callers in the Merin Kenny home.

Car Outside All WINTER?

You Need New D-X Special Motor Oil

It's "Weather-Proofed!" New D-X Special Motor Oil flows at 50° below zero. It gives you faster, easier starts—reaches vital engine parts with more protection. Yet, new D-X Special refuses to thin out—resists burning up like no previous oil could.

So, winter or summer, use D-X Special, the motor oil that's "weather-proofed." Sold with an absolute money-back guarantee!

MERCHANT OIL CO.
121 West 1st Phone 99

HEY KIDS ... FREE Train Rides IN WAYNE Friday and Saturday, Nov. 25-26

Get Free Tickets From Wayne Firms Displaying Window Signs

BRING YOUR FOLKS AND HAVE FUN IN WAYNE RIDING THE LITTLE TRAIN

Friday, 2:30 - 5:30 P.M. Saturday, 2:30 - 9:30 P.M.

Sponsored By Wayne Chamber of Commerce

STOP - GO

WHEN YOU NEED TO! WHEN YOU WANT TO!

WITH **NEW Firestone Town & Country WINTER TIRES**

FOR USE EITHER WITH A TUBE OR TUBELESS

Put Them on Your Present Car—No Special Wheels or Rims Required.

- GRIP BETTER ON ICE
- STOP QUICKER IN RAIN
- PULL BETTER IN SNOW OR MUD

We'll Equip Both Rear Wheels for AS \$200 A WEEK AS

They're NOISELESS

Merchant Oil Co.
121 W. 1st Phone 99

'H' Club Organized at High School; Scheurich President

Hoskins high school athletes organized the "H" club Thursday. Paul Scheurich was elected president.

Other officers named were Bob Fletcher, vice president, and Gerald Wittler, secretary-treasurer. Named to a committee to prepare a constitution and bylaws were Bill Marquardt, Scheurich, Randall Krause and Gene Ehrlich.

Hoskins opened its basketball season Friday against Thurston. The Huskies have lost Scheurich, a 6-3 center, for the first semester as he was declared ineligible. Ehrlich was moved to center and Bill Opler switched from guard to forward.

Cheerleaders are Char Lott, Kleinbach, Mary Ann Pingel, Jacqueline Mittelstead, Sandra Asmus, Ruth Nurnberg and Deloris Galinat.

Family Night
Members of the Hoskins EUB church enjoyed a family gathering Sunday night. A film was shown by Rev. Paul Riggs, who also led devotions.

Move to Colorado
Mr. and Mrs. Clifford Pentico, Douglas and Connie Sue moved Thursday morning to Golden, Colo. where Mr. Pentico will be employed. Mr. and Mrs. Hans P. Hansen accompanied Penticos to spend ten days with them.

Mr. and Mrs. Fred Puls, Norfolk, Mrs. Louisa Strate, Mr. and Mrs. Frank Marten, Mr. and Mrs. Samuel Ulrich and LaDonna, and Mrs. Erwin Ulrich were Sunday visitors in the Ernest Puls home.

Mr. Harry Brummels and Willard and Delma Lieneman, Randolph, were Friday afternoon visitors in the Ernest Puls home. Mrs. Minnie Brueckner, who spent the past week in the home of her brother, Harry and family, returned with them.

Mr. and Mrs. Fred Brumley visited Thursday night in the Ernest Puls home.

Mr. and Mrs. Samuel Ulrich and LaDonna were Sunday dinner guests in the Erwin Ulrich home.

Mr. and Mrs. Fred Hillen, Mr.

and Mrs. Lawrence Hillen and family, Mr. and Mrs. Dave Leucker and Christine, Emelia Schroeder and Mr. and Mrs. Albert Meierhenry and sons were visitors in the Ernest Strate home Sunday.

Mr. and Mrs. Louis Bendin and Mr. and Mrs. J. E. Pingel were among guests attending the pinocchle party at the Ben Fuelbirth home, Osmond, Sunday evening.

Mr. and Mrs. Hays P. Hansen and Mr. and Mrs. August Spengler, Norfolk, were visitors in the Mrs. Minnie Krause home Tuesday evening.

Mr. and Mrs. Hays Asmus, Artoe and Gary were visitors in the Ed Maas home Sunday evening.

Mr. and Mrs. Edwin Brogren, Yvonne and Lois were Thursday evening visitors in the Ed Shellenberg home.

Mr. and Mrs. Peto Moody and Loren were Sunday dinner guests in the home of Mrs. Moody's mother, Mrs. William McKenzie, Wisner.

Get-to-Gether Club
Mrs. Gilbert Fletcher entertained Get-to-Gether club Thursday afternoon. Pitch prizes were awarded to Mrs. Glen Frink and Mrs. Clarence Johnson. The group voted to have a Christmas party, Dec. 15 meeting will be held at Mrs. Clarence Johnson's home.

Family Night
Members of Peace E. and R. church held a Thanksgiving family night supper Friday. Rev. Richard Griffith, missionary candidate to Oslo, Norway, was the featured speaker during the devotional hour which followed. Other slides of work in that area were also shown. Rev. Griffith sang two solos. Rev. and Mrs. George Heusinger conducted games, contests and relays.

Society . . .

A-Teen Club
A-Teen club members will meet at the Walter Schellpepper home Dec. 14 instead of the Walter Sloan home.

Garden Club
Mrs. Ernest Langenberg entertained Hoskins Garden club members Tuesday afternoon. Mrs. E. M. Redden, Mrs. Phillip Raasch and Mrs. Frank Miller, Norfolk, Mrs. Dale Langenberg, Pierce, and Mrs. Donald Loderman were guests. Mrs. Langenberg conducted the business meeting. Mrs. Louis Bendin gave a lesson on ferns. Mrs. Round table discussion was on migration of birds. Dec. 14 meeting will be at the Mrs. Willard Maas home.

North Valley Club
Mrs. Claus Rathman was hostess to North Valley Extension club Thursday afternoon. Mrs. Louis Bendin was in charge of the business meeting. Plans were made

to have a Christmas party and entertain husbands and families at the Dec. 16 meeting at the Ed Shellenberg home. Mrs. Maas and Mrs. Edward Shellenberg gave the lesson on landscaping.

Mr. and Mrs. Emil Gutzmann were visitors in the Oliver Kiesau home Tuesday evening.

Mary Ann Pingel was an overnight guest of Charlotte Kleinbach Wednesday.

Mrs. Paul Beckman who is visiting her parents, entertained the following ladies for her mother, Mrs. Herman Jochens, last Monday afternoon. Guests were Mrs. E. A. Strate, Mrs. Minnie Krause and Marjorie, Mrs. Martha Rohrke, Mrs. Emilie Schmidt, Mrs. Peter Ulrich, Mrs. E. O. Bohner, Mrs. Clarence Schroeder and Mrs. Elsie Mankso. Mrs. Beckman returned to her home Tuesday after spending the past week with her parents.

Arlene Asmus, Marlene Lorenz and Jacqueline Mittelstead were overnight guests of Phyllis Maas Thursday.

Mr. and Mrs. Frank Miller, Norfolk, were visitors in the Ernest Langenberg home Tuesday evening.

PTC Group Planning Christmas Fete Dec. 8
Parochial PTC association met at Trinity school Thursday night. Plans were made for a Christmas party Dec. 8 at the school. Mr. and Mrs. Marvin Miebach, Mrs. Alvin Wagner and Mrs. J. E. Pingel were named to the entertainment committee. Mrs. Willard Maas and Mrs. G. B. Frank are in charge of decorations.

Miebach discussed the insurance policy plan. Rev. G. B. Frank conducted the meeting. Dr. W. Klonfer and H. Wiley, Norfolk State hospital, gave lectures on children's emotions and showed a film.

Mr. and Mrs. Ed Schroeder and Mr. and Mrs. Leonard Norling, Norfolk, were Sunday afternoon guests in the Edward Shellenberg home.

Mr. and Mrs. Everett Newman and family were visitors in the Eimer Maas home Sunday evening.

Mr. and Mrs. Harlan Herbershmer, Jeannette and DyAnn, Pierce, were supper guests in the Everett Newman home Thursday evening.

Kirt Lee and Karmen Shellenberg spent Thursday in the home of their grandparents, Mr. and Mrs. Ed Shellenberg.

Mr. and Mrs. Arthur Bohmer were dinner guests at the Alvin Spreeman home, Norfolk, Sunday.

Mr. and Mrs. Louis Bendin and Janelle and Dr. and Mrs. Louis Mittelstead were evening visitors in the John Drevsen home Saturday.

HOSKINS NEWS

Mrs. J. E. Pingel, Phone 73

day, Mr. and Mrs. Harry Drevsen and Janet Kay were afternoon visitors.

Mr. and Mrs. Robert Nurnberg, Ruth and Gene, were among guests attending the wedding and reception of Ceda Rice and Vern Hansen Saturday evening at Tekamah.

Mrs. Nurnberg was president of the table waitresses, Vern Hansen is Mrs. Nurnberg's nephew.

Mr. and Mrs. Frank Miller attended the wedding and reception of Mr. Miller's grand niece, Marcella Miller, Verdridge and Joe Forell, Niobrara, Wednesday in Verdridge.

Mr. and Mrs. Frank Miller were supper guests at the Irwin Miller home, Verdridge, Wednesday.

Jack Pingel spent last weekend with Eric Kadke, Aurelia, Ia.

Mr. and Mrs. Robert Nurnberg, Ruth and Gene, were Saturday evening guests in the Ed Hansen home, Tekamah.

Mr. and Mrs. Willard Maas (Mrs. Wayne Thomas, Mrs. Mattie Voss, Mrs. Hans Asmus and Anna Wontoch. Mr. and Mrs. Rudy Witte were supper guests in the Steve Porter home, Wynside, Sunday.

Mr. and Mrs. J. E. Pingel, Mary Ann and Dickie, were supper guests in the Louis Bendin home Monday. Mr. and Mrs. Harry Drevsen and Janet Kay were evening visitors.

Mr. and Mrs. Frank Miller, Norfolk, Mrs. Emil Gutzman, Mrs. Wayne Thomas and Mrs. Lyle Marotz were visitors in the J. E. Pingel home Wednesday evening.

Mr. and Mrs. Cliver Kiesau were visitors in the Herbert Schwindt home, Stanton, Thursday evening.

Mr. and Mrs. Robert Nurnberg were Monday evening visitors in the Hubert Ehrlich home.

Mr. and Mrs. Paul Rohrke, Norfolk, were Sunday evening visitors in the Mrs. Martha Rohrke home.

Mr. and Mrs. Herman Weichenenthal and Mr. and Mrs. Art Weichenenthal, Stanton, and Hattie Thickett, Pilger, were visitors in the Mrs. Emilie Schmidt home Sunday afternoon.

Mr. and Mrs. J. E. Pingel and Mr. and Mrs. Louis Bendin were supper guests in the Mrs. Pauline Wubbenhorst home, Osmond, Sunday evening.

Mrs. Fred Carson was a Sunday evening guest in the Mrs. Emilie Schmidt home.

Firemen Answer Four Calls in Hoskins Area
Hoskins volunteer firemen answered four calls during the past week.

A truck loaded with straw and a straw pile were destroyed at the Don Deerman home last Monday afternoon. After loading the truck, Deerman started the motor but it backfired and ignited the load. Strong winds fanned the blaze and the fire was out of control by the time firemen arrived. It also spread to a field nearby.

A fire on the William Pieper farm was also destroyed recently.

Last Wednesday firemen were called to the Gus Deck farm four miles east of town when bedding stored in a second story room burst through a window.

It is believed the fire started Tuesday night when members of the family went to the storeroom to get more bedding. Cigarette ashes may have fallen in bedding which was left.

The fire was not discovered until about noon Wednesday when the stairway door was opened. The second floor was filled with smoke.

Saturday firemen answered a call at the Dwight Bruggeman home caused by a smoking furnace. No damage was reported.

Churches

Trinity Lutheran Church Wisconsin Synod (G. B. Frank, pastor) Sunday, Nov. 27: Divine service, 10 a.m.; Sunday school, 11. Tuesday, Nov. 29: Church council, 8 p.m. Wednesday, Nov. 30: Nominating committee, 8 p.m.

Evan, United Brethren Church (Paul H. Riggs, pastor) Sunday, Nov. 27: Sunday school, 10 a.m.; worship, "New Tasks for New Times," 11; evening service, "The Human Coin," 7:30 p.m. Tuesday, Nov. 29: Brotherhood.

Mr. and Mrs. Herman Kremke, Randolph, were supper guests in the Louis Bendin home Friday.

Mr. and Mrs. Dick Glaze and Janet and Mr. and Mrs. Harry Strate and family were supper guests in the Hubert Ehrlich home Monday.

Joan Strate was an overnight guest of Dorinda Ehrlich Monday.

Mrs. J. E. Pingel, Mary Ann and Dickie were visitors in the Frank Miller home Saturday evening.

The following ladies from Hoskins attended the hospital aid meeting Wednesday afternoon at Norfolk: Mrs. Martha Rohrke.

Mr. and Mrs. Melvin Nydahl and family were Sunday evening visitors in the Carl Hinzman home.

Mrs. Wayne Thomas spent Thursday and Friday in the Mrs. E. A. Morris home, Carroll.

Mr. and Mrs. Wayne Thomas were dinner guests Sunday in the Robert Thomas home.

Mr. and Mrs. Walter Strate were visitors in the Hans Asmus home Saturday evening.

Mrs. August Spengler spent Monday in the Wayne Thomas home.

Mr. and Mrs. Paul Miller, Norfolk, were visitors in the Hans Asmus home Monday morning.

Mr. and Mrs. Art Weichenenthal, Pilger, were Sunday afternoon callers in the Ed Kollath home.

Mr. and Mrs. Glen Frink and daughters were visitors Sunday afternoon in the Walter Rethwisch home, Carroll.

Danny and Diane Bruggeman and Lanny Maas were supper guests at the Hans Asmus home Friday.

Mr. and Mrs. Ed Kollath were Sunday afternoon visitors in the Henry Deck home, Norfolk.

Mr. and Mrs. Vernon Behmer and family were Sunday afternoon guests at the Wendel Rohrbach home, Osmond.

A no-host family dinner was held Sunday at the Donald Meierhenry home, Petersburg. Guests were: Mr. and Mrs. Carl Hinzman, Mr. and Mrs. Ed Meierhenry, Mr. and Mrs. Reuben Puls and Denise, Mr. and Mrs. Melvin Nydahl and family, Mr. and Mrs. Dave Miller and family, Mr. and Mrs. Gene Koehn and Susan, Norfolk, and Mr. and Mrs. Clifford Bossard and family, Tilden.

Mr. and Mrs. Harry Weither and family were visitors on Thursday evening.

Winside
By Gladys Reichert
Phone 2692, Winside
(Continued from Page 3)

Mr. and Mrs. Gene Behmer and daughters were Thursday evening visitors in the W. F. Dangberg home.

Mr. and Mrs. Frank Bright, Norfolk, were Sunday evening visitors in the George Koll home.

Gale Miller and Helen Leitig were supper guests in the Andrew Mann home Thursday evening.

Mr. and Mrs. Rolv Dietrick were Sunday afternoon guests in the Walter Carpenter home.

Mr. and Mrs. Carl Mann and Jean, Hoskins, were visitors in the Andrew Mann home Thursday evening.

Elsie Wylie and Ann Marie Hoffman, Norfolk, spent Saturday night and Sunday in the Chester Wylie home.

Mr. and Mrs. Dave Lueker and Christine and Amelia Schroeder were visitors in the E. A. Strate home, Hoskins, Sunday evening.

Mr. and Mrs. Marvin Schroeder entertained Mr. and Mrs. Fred Schroeder, Norfolk, and Mr. and Mrs. Robert Blake and Patricia Lynn, Patuxent River, Md., at dinner Tuesday noon. Mrs. Dave Lueker and Christine were afternoon visitors in the Schroeder home.

Visitors at the Alvin Bargstadt home Thursday evening were Mr. and Mrs. George Ehlers and family, Hoskins, Mr. and Mrs. Clifford Rohde and family, Carroll and

ersep and family and Mr. and Mrs. George Ehlers and family.

Mr. and Mrs. Clarence Schroeder entertained the Birthday group at their home in honor of Mrs. Schroeder's Thursday night. Pitch prizes went to Mr. and Mrs. Ernest Machmiller, Mr. and Mrs. Ed Maas and Mr. and Mrs. Hans Asmus.

Mr. and Mrs. Melvin Nydahl and family were Sunday evening visitors in the Carl Hinzman home.

Mrs. Wayne Thomas spent Thursday and Friday in the Mrs. E. A. Morris home, Carroll.

Mr. and Mrs. Wayne Thomas were dinner guests Sunday in the Robert Thomas home.

Mr. and Mrs. Walter Strate were visitors in the Hans Asmus home Saturday evening.

Mrs. August Spengler spent Monday in the Wayne Thomas home.

Mr. and Mrs. Paul Miller, Norfolk, were visitors in the Hans Asmus home Monday morning.

Mr. and Mrs. Art Weichenenthal, Pilger, were Sunday afternoon callers in the Ed Kollath home.

Mr. and Mrs. Glen Frink and daughters were visitors Sunday afternoon in the Walter Rethwisch home, Carroll.

Danny and Diane Bruggeman and Lanny Maas were supper guests at the Hans Asmus home Friday.

Mr. and Mrs. Ed Kollath were Sunday afternoon visitors in the Henry Deck home, Norfolk.

Mr. and Mrs. Vernon Behmer and family were Sunday afternoon guests at the Wendel Rohrbach home, Osmond.

A no-host family dinner was held Sunday at the Donald Meierhenry home, Petersburg. Guests were: Mr. and Mrs. Carl Hinzman, Mr. and Mrs. Ed Meierhenry, Mr. and Mrs. Reuben Puls and Denise, Mr. and Mrs. Melvin Nydahl and family, Mr. and Mrs. Dave Miller and family, Mr. and Mrs. Gene Koehn and Susan, Norfolk, and Mr. and Mrs. Clifford Bossard and family, Tilden.

Mr. and Mrs. Harry Weither and family were visitors on Thursday evening.

'I See by the Herald'
Mr. and Mrs. Phillip March called in the Alpha Lake home, Hawarden, Ia., Monday.

Last weekend Mr. and Mrs. Charles McDermott visited his parents.

Mr. and Mrs. Dewey Jensen and family.

Legion Auxiliary Plans Christmas Dinner Dec. 10
Legion Auxiliary met at the Legion hall Saturday afternoon and made plans for a Christmas dinner Dec. 10. Mrs. H. J. Podoll, Mrs. Joy Podoll and Mrs. Donald Quinn are hostesses.

Mrs. Norman Deck and Mrs. Dale Snelson were guests and became members. Reports on the annual smorgasbord were given by Mrs. N. L. Ditman and Mrs. George Voss.

Auxiliary and the Legion will send gifts to hospitalized veterans and serve them. Reports on the annual smorgasbord were given by Mrs. N. L. Ditman and Mrs. George Voss.

Mrs. Chester Wylie, Frances Wylie and Mrs. Jack Sweigard were named to make tabletons to send to state hospitals. A carpet rag bee will be held Wednesday.

Mrs. Bill Hoffman read an article on Thanksgiving. Mrs. Clarence Pfeiffer read an essay. Mrs. Hoffman and Mrs. Wilfred Miller served lunch.

Mr. and Mrs. Arthur Rabe and Mr. and Mrs. George Farran were Sioux City visitors Friday.

Mr. and Mrs. R. H. Thompson and Mrs. W. J. Misteid, spent Friday morning in Norfolk.

Mr. and Mrs. George Farran and family gave dinner guests Wednesday evening at the Charles Brockman home.

Fred G. Miller, Valparaiso, Ind., left Friday for his home after spending the past two weeks with Mr. and Mrs. Glenn Hamm.

Mr. and Mrs. Norris Weible and family, Wayne, Mr. and Mrs. Clarence Pfeiffer and family and Mr. and Mrs. Donald Pfeiffer and family were guests at the Martin Pfeiffer home Thursday evening in honor of Mr. Pfeiffer's birthday.

Mr. and Mrs. Harold McDermott, Holstein, Ia., Mr. and Mrs. R. H. Hansen and Mrs. Anna Mau visited Mrs. Burdette Hansen, Wisner, in a Sioux City hospital Friday.

Friday evening supper guests in the Claude Harder home were Mr. and Mrs. Roy Spahr and Mrs. L. Ireland. They helped celebrate Claudette's birthday.

Last Monday Mrs. Charles Millie entertained friends and neighbors at coffee for her birthday.

Marion Scott Mallory, 67, former Wayne resident, died Oct. 26 at Medford, Ore.

Harry Lyons was a dinner guest Sunday at the Hans Rethwisch home.

Mr. and Mrs. C. H. Raw, Sioux City, were guests of Art Aukers Friday night.

Mr. and Mrs. Fred Puls, Norfolk, Mrs. Louisa Strate, Mr. and Mrs. Frank Marten, Mr. and Mrs. Samuel Ulrich and LaDonna, and Mrs. Erwin Ulrich were Sunday visitors in the Ernest Puls home.

Mr. Harry Brummels and Willard and Delma Lieneman, Randolph, were Friday afternoon visitors in the Ernest Puls home. Mrs. Minnie Brueckner, who spent the past week in the home of her brother, Harry and family, returned with them.

Mr. and Mrs. Fred Brumley visited Thursday night in the Ernest Puls home.

Mr. and Mrs. Samuel Ulrich and LaDonna were Sunday dinner guests in the Erwin Ulrich home.

Mr. and Mrs. Fred Hillen, Mr.

Mr. and Mrs. Ernest Langenberg entertained Hoskins Garden club members Tuesday afternoon. Mrs. E. M. Redden, Mrs. Phillip Raasch and Mrs. Frank Miller, Norfolk, Mrs. Dale Langenberg, Pierce, and Mrs. Donald Loderman were guests. Mrs. Langenberg conducted the business meeting. Mrs. Louis Bendin gave a lesson on ferns. Mrs. Round table discussion was on migration of birds. Dec. 14 meeting will be at the Mrs. Willard Maas home.

North Valley Club
Mrs. Claus Rathman was hostess to North Valley Extension club Thursday afternoon. Mrs. Louis Bendin was in charge of the business meeting. Plans were made

Mr. and Mrs. Fred Puls, Norfolk, Mrs. Louisa Strate, Mr. and Mrs. Frank Marten, Mr. and Mrs. Samuel Ulrich and LaDonna, and Mrs. Erwin Ulrich were Sunday visitors in the Ernest Puls home.

Mr. Harry Brummels and Willard and Delma Lieneman, Randolph, were Friday afternoon visitors in the Ernest Puls home. Mrs. Minnie Brueckner, who spent the past week in the home of her brother, Harry and family, returned with them.

Mr. and Mrs. Fred Brumley visited Thursday night in the Ernest Puls home.

Mr. and Mrs. Samuel Ulrich and LaDonna were Sunday dinner guests in the Erwin Ulrich home.

Mr. and Mrs. Fred Hillen, Mr.

PLAN NOW to ATTEND SIOUX CITY'S 4TH ANNUAL AUTO SHOW
NOV. 30, DEC. 1-2-3-4
MUNICIPAL AUDITORIUM
5 BIG THRILLING ACTS • NEW CARS

Featuring:
• PEG-LEG BATES
• RANDY BROWN (M.C.)
• THE ADAROS
• MIMI HINES and PHIL FORD
• THE WILLY KIDS

SPECIAL WORKSHOP ON SALE OF USED CARS, DEC. 1. DOORS OPEN AT 1:30 P. M. EVENING SHOWS - 7:00 P. M. - 10:00 P. M. ADMITTANCE FREE.

ADULTS 90c
STUDENTS AND SERVICE MEN BY ENIFORM 45c
TAX INCLUDED

Tickets on Sale at Auditorium Boxoffice, Children Under School Age FREE with Parents. Sponsored by Sioux City Auto Dealers Association.

It Happened In NEBRASKA...



When the first telegraph poles extended 12 miles past Fort Kearney, Indians became disturbed and burned the poles. Later, two chiefs—500 miles apart—were invited to "talk" over the wires. When they were brought together to compare notes, they found the wires did indeed contain awesome magic!

But there's no "magic" in the way Nebraska taverns have earned public acceptance. Tavern owners have worked hard to build a high ethical industry. You can see the result in the clean, respectable atmosphere of your local tavern.

NEBRASKA DIVISION
United States Brewers Foundation
710 First Nat'l Bank Bldg., Lincoln

Gambles The Friendly Store

NOT RETREADS! NOT SECONDS!

ALL BRAND NEW TIRES!

GUARANTEED QUALITY

BE SAFE! BUY A PAIR AT THESE LOW PRICES

WINTER MASTER MUD AND SNOW TIRES

- Sure-Grip Traction for Rugged Winter Weather
- Have Amazing Self-Cleaning Tread Design

It's not too early to plan for winter driving! Now is the time to equip your car with all new "Winter Master" mud and snow tires. They cost little more than the others charge for a retread, yet they're all first quality, made with cold rubber tread and all rayon carcass. Despite the worst weather conditions, "Winter Master" give better traction and reduce skid danger. Quiet running, without annoying clapping noises. Guaranteed 12 months against road hazards, for life against defects.

Keep Your Present Tires, No Trade-in Needed!

ALWAYS BETTER BUYS AT GAMBLES

14.95 600 x 16 PLUS TAX

670x15 15.50*
710x15 17.50*
760x15 18.95*
*plus tax

Gambles

21" TV CONSOLE
At the Price of a 17" Table Model

POSITIVELY YOUR NO. 1 VALUE

YOU SAVE \$40

Regular Price \$199.95

159.95

- Aluminized Tube for a Clear, Bright Picture
- Controls on Top, Out of Reach of Small Children
- Smart Modern Cabinet Finished in Mahogany

Treat yourself to the tops in TV! CORONADO Shelby gives steady, clear reception, has automatic focus, 6" PM Alnico speaker. Styled with tapered brass-finish legs, smart tweed front. Warranted.

KIDS - GET FREE TRAIN RIDE TICKETS HERE FOR THE MINIATURE TRAIN,
November 25 - 26

Thanksgiving Dance
THURSDAY, NOV. 24
TONY BRADLEY and His Orchestra
Adm. \$1.00 tax paid

Dennis Weisely and His Orchestra
SATURDAY, NOV. 26
Adm. 50c

"TINY" HILL
America's BIGGEST Bandleader and His Orchestra
SUNDAY, NOV. 27
Adm. \$1.50 tax paid

SQUARE DANCE
to Harold Bausch
"The Singing Caller"
WEDNESDAY, NOV. 30
Adm. 50c

Gambles

21" TV CONSOLE
At the Price of a 17" Table Model

POSITIVELY YOUR NO. 1 VALUE

YOU SAVE \$40

Regular Price \$199.95

159.95

- Aluminized Tube for a Clear, Bright Picture
- Controls on Top, Out of Reach of Small Children
- Smart Modern Cabinet Finished in Mahogany

Treat yourself to the tops in TV! CORONADO Shelby gives steady, clear reception, has automatic focus, 6" PM Alnico speaker. Styled with tapered brass-finish legs, smart tweed front. Warranted.

KIDS - GET FREE TRAIN RIDE TICKETS HERE FOR THE MINIATURE TRAIN,
November 25 - 26

WE'LL BE OPEN NIGHTS TO 9:30 ON DATES SHOWN IN BLACK ON CALENDAR

1955 DECEMBER 1955

S	M	Tu	W	Th	F	Sa
			1	2	3	4
5	6	7	8	9	10	11
12	13	14	15	16	17	18
19	20	21	22	23	24	25
26	27	28	29	30	31	